

Contents

01	HEAD PROTECTION
22	EYE PROTECTION
29	HEARING PROTECTION
36	RESPIRATOR PROTECTION
43	HAND PROTECTION
49	FALL PROTECTION EQUIPMENTS
65	MARINE LIFE JACKETS
66	RAINWEAR PROTECTION & PROTECTION CLOTHING
73	SAFETY VEST & TRAFFIC CONTROL EQUIPMENTS
80	SAFETY FOOTWEAR
86	EMERGENCY RESPONSE, EYEWASH & SHOWERS
97	SAFETY CANS, CABINETS, SPILL CONTROL & SAFETY PRODUCTS
109	SAFETY SIGNAGES
134	GENERAL TECHNICAL INFORMATIONS
146	INDEX



HEAD PROTECTION

PROGUARD SAFETY PRODUCTS CATALOGUE

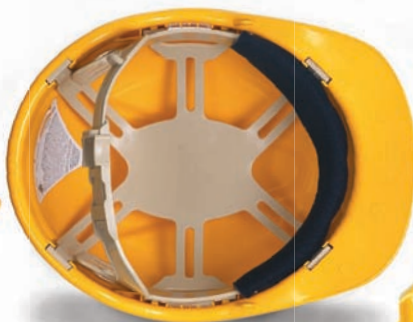

Advantage 1 - Slide Lock HG1-PHSL

- ABS shell fixed with unique slide-lock which is an easily adjustable, comfortable and user friendly locking system.
- This slide-lock headband which specially designed together with 8-point moulded shock absorbing suspension system provides essential crown clearance to absorb impact energy.
- Comply to MS183, ANSI Z89.1 & EN397 • 1 pc/polybag 40pcs/carton

HG1-PHSL



Advantage 1 - Pin Lock HG1-S2PHPL

- ABS shell fixed with pin-lock which is an easily adjustable, comfortable and user friendly locking system.
- This pin-lock headband which specially designed together with 8-point moulded shock absorbing suspension system provides essential crown clearance to absorb impact energy.
- Comply to MS183, ANSI Z89.1 & EN397 • 1 pc/polybag 20pcs/carton

HG1-S2PHPL



Advantage 1 - Push Lock HG1-S2PHPB

- ABS shell fixed with **patented** Push-Lock harness which is a useful improvements compare to conventional headband that are easily adjustable to their circumference & comfortably accommodate different head size.
- This Push-Lock headband which specially designed together with **patented** 8-point moulded **Energy Absorber** suspension system provides essential crown clearance to absorb impact energy.
- Comply to MS183, ANSI Z89.1 & EN397 • 1 pc/polybag 20pcs/carton

HG1-S2PHPB





HG1-WHG3PB

Advantage 1 - Push Lock HG1-WHG3PB

- ABS shell fixed with **patented** Push-Lock harness which is a useful improvements compare to conventional headband that are easily adjustable to their circumference & comfortably accommodate different head size.
- This Push-Lock headband which specially designed together with **patented** 8-point terylene webbing **Energy Absorber** suspension system provides essential crown clearance to absorb impact energy.
- Comply to MS183, ANSI Z89.1 & EN397 • 1 pc/polybag 24pcs/carton



HG1-WHG3PL



Advantage 1 - Pin Lock HG1-WHG3PL

- ABS shell fixed with unique pin-lock which is an easily adjustable, comfortable and user friendly locking system.
- This pin-lock headband which specially designed together with 8-point terylene webbing suspension system provides essential crown clearance to absorb impact energy.
- Comply to MS183, ANSI Z89.1 & EN397 • 1 pc/polybag 24pcs/carton



HG1-WHG3RS

Advantage 1 - Stealth Lock HG1-WHG3RS

- ABS shell fixed with **patented** Stealth-Lock which is an easily adjustable, comfortable and user friendly locking system.
- This ratchet headband which specially designed together with 8-point terylene webbing suspension system provides essential crown clearance to absorb impact energy.
- Comply to MS183, ANSI Z89.1 & EN397 • 1 pc/polybag 12pcs/carton





HG2-PHSL

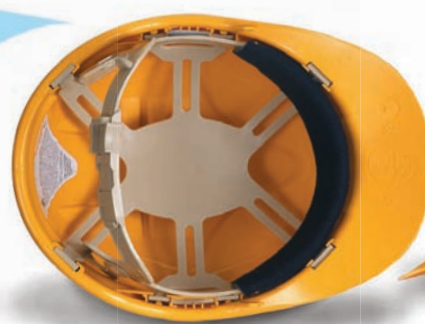

Advantage 2 - Slide Lock HG2-PHSL

- Modern design & spacious shell manufacturer from ABS with distinctive side cooling vent which increase air flow & reduced heat built up.
- Fixed with unique slide-lock which is an easily adjustable, comfortable and user friendly locking system.
- This slide-lock headband which specially designed together with 8-point moulded shock absorbing suspension system provides essential crown clearance to absorb impact energy.
- Comply to MS183, ANSI Z89.1 & EN397 • 1 pc/polybag 40pcs/carton



Advantage 2 - Pin Lock HG2-S2PHPL

- Modern design & spacious shell manufacturer from ABS with distinctive side cooling vent which increase air flow & reduced heat built up.
- Fixed with pin-lock which is an easily adjustable, comfortable and user friendly locking system.
- This pin-lock headband which specially designed together with 8-point moulded shock absorbing suspension system provides essential crown clearance to absorb impact energy.
- Comply to MS183, ANSI Z89.1 & EN397 • 1 pc/polybag 20pcs/carton



HG2-S2PHPL



Advantage 2 - Push Lock HG2-S2PHPB

- Modern design & spacious shell manufacturer from ABS with distinctive side cooling vent which increase air flow & reduced heat built up.
- Fixed with **patented** Push-Lock harness which is a useful improvements compare to conventional headband that are easily adjustable to their circumference & comfortably accommodate different head size.
- This Push-Lock headband which specially designed together with **patented** 8-point moulded **Energy Absorber** suspension system provides essential crown clearance to absorb impact energy.
- Comply to MS183, ANSI Z89.1 & EN397 • 1 pc/polybag 20pcs/carton



HG2-S2PHPB



HEAD PROTECTION

PROGUARD SAFETY PRODUCTS CATALOGUE



HG2-WHG3PB

Advantage 2 - Push Lock HG2-WHG3PB

- Modern design & spacious shell manufacturer from ABS with distinctive side cooling vent which increase air flow & reduced heat built up.
- Fixed with **patented** Push-Lock harness which is a useful improvements compare to conventional headband that are easily adjustable to their circumference & comfortably accommodate different head size.
- This Push-Lock headband which specially designed together with **patented** 8-point terylene webbing **Energy Absorber** suspension system provides essential crown clearance to absorb impact energy.
- Comply to MS183, ANSI Z89.1, AS/NZS1801 & EN397
- 1 pc/polybag 24pcs/carton

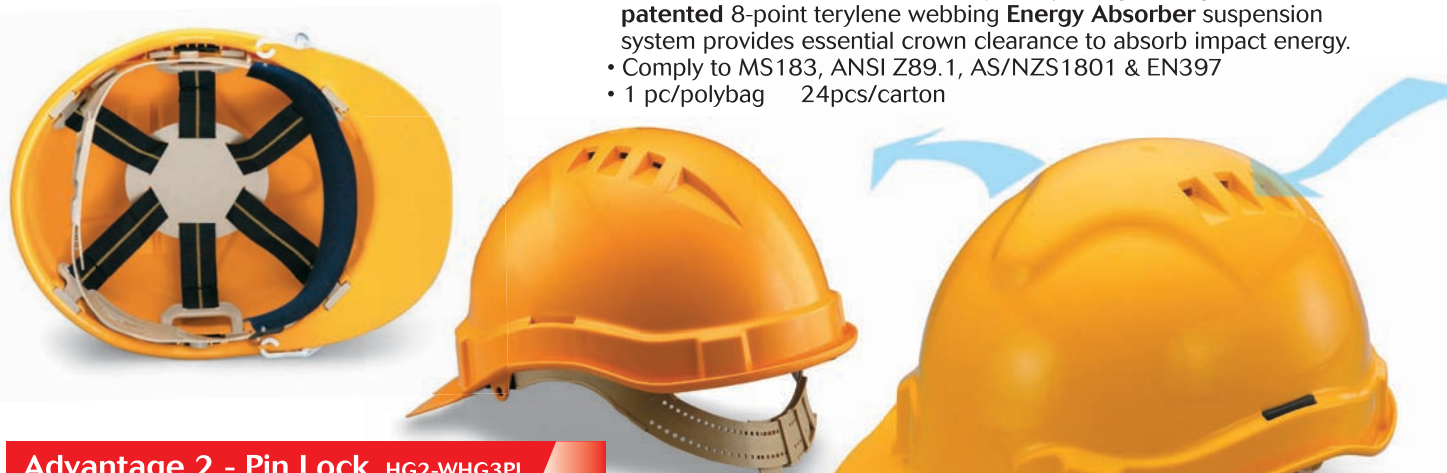

HG2-WHG3PL

Advantage 2 - Pin Lock HG2-WHG3PL

- Modern design & spacious shell manufacturer from ABS with distinctive side cooling vent which increase air flow & reduced heat built up.
- Fixed with unique pin-lock which is an easily adjustable, comfortable and user friendly locking system.
- This pin-lock headband which specially designed together with 8-point terylene webbing suspension system provides essential crown clearance to absorb impact energy.
- Comply to MS183, ANSI Z89.1, AS/NZS1801 & EN397 • 1 pc/polybag 24pcs/carton



HG2-WHG3RS

Advantage 2 - Stealth Lock (Ratchet) HG2-WHG3RS

- Modern design & spacious shell manufacturer from ABS with distinctive side cooling vent which increase air flow & reduced heat built up.
- Fixed with **patented** Stealth-Lock which is an easily adjustable, comfortable and user friendly locking system.
- This ratchet headband which specially designed together with 8-point terylene webbing suspension system provides essential crown clearance to absorb impact energy.
- Comply to MS183, ANSI Z89.1, AS/NZS1801 & EN397 • 1 pc/polybag 12pcs/carton





HG3-PHSL

Advantage 3 - Slide Lock HG3-PHSL

- Modern design & spacious shell manufacturer from ABS.
 - Fixed with unique slide-lock which is an easily adjustable, comfortable and user friendly locking system.
 - This slide-lock headband which specially designed together with 8-point moulded shock absorbing suspension system provides essential crown clearance to absorb impact energy.
 - Comply to MS183, ANSI Z89.1 & EN397
- 1 pc/polybag 40pcs/carton



HG3-S2PHPL

Advantage 3 - Pin Lock HG3-S2PHPL

- Modern design & spacious shell manufacturer from ABS.
 - Fixed with pin-lock which is an easily adjustable, comfortable and user friendly locking system.
 - This pin-lock headband which specially designed together with 8-point moulded shock absorbing suspension system provides essential crown clearance to absorb impact energy.
 - Comply to MS183, ANSI Z89.1 & EN397
- 1 pc/polybag 20pcs/carton



HG3-S2PHPB



Advantage 3 - Push Lock HG3-S2PHPB

- Modern design & spacious shell manufacturer from ABS.
 - Fixed with **patented** Push-Lock harness which is a useful improvements compare to conventional headband that are easily adjustable to their circumference & comfortably accommodate different head size.
 - This Push-Lock headband which specially designed together with **patented** 8-point moulded **Energy Absorber** suspension system provides essential crown clearance to absorb impact energy.
 - Comply to MS183, ANSI Z89.1 & EN397
- 1 pc/polybag 20pcs/carton





HG3-WHG3PB

Advantage 3 - Push Lock HG3-WHG3PB

- Modern design & spacious shell manufacturer from ABS.
- Fixed with **patented** Push-Lock harness which is a useful improvements compare to conventional headband that are easily adjustable to their circumference & comfortably accommodate different head size.
- This Push-Lock headband which specially designed together with **patented** 8-point terylene **Energy Absorber** webbing suspension system provides essential crown clearance to absorb impact energy.
- Comply to MS183, ANSI Z89.1, AS/NZS1801 & EN397
- 1 pc/polybag 24pcs/carton



HG3-WHG3PL



Advantage 3 - Pin Lock HG3-WHG3PL

- Modern design & spacious shell manufacturer from ABS.
- Fixed with unique pin-lock which is an easily adjustable, comfortable and user friendly locking system.
- This pin-lock headband which specially designed together with 8 point terylene webbing suspension system provides essential crown clearance to absorb impact energy.
- Comply to MS183, ANSI Z89.1, AS/NZS1801 & EN397
- 1 pc/polybag 24pcs/carton



HG3-WHG3RS

Advantage 3 - Stealth Lock (Ratchet) HG3-WHG3RS

- Modern design & spacious shell manufacturer from ABS.
- Fixed with **patented** Stealth-Lock which is an easily adjustable, comfortable and user friendly locking system.
- This ratchet headband which specially designed together with 8 point terylene webbing suspension system provides essential crown clearance to absorb impact energy.
- Comply to MS183, ANSI Z89.1, AS/NZS1801 & EN397
- 1 pc/polybag 12pcs/carton



HEAD PROTECTION

PROGUARD SAFETY PRODUCTS CATALOGUE



Optimus 11 - Slide Lock TFM11-PHSL

- Ultra modern design & spacious shell manufacturer from ABS with distinctive front cooling vent which provides excellent air flow & reduced heat built up.
- Fixed with unique slide-lock which is an easily adjustable, comfortable and user friendly locking system.
- This slide-lock headband which specially designed together with 8 point moulded shock absorbing suspension system provides essential crown clearance to absorb impact energy.
- Comply to MS183, ANSI Z89.1 & EN397 • 1 pc/polybag 40pcs/carton

TFM11-PHSL



Optimus 11 - Pin Lock TFM11-S5PHPL

- Ultra modern design & spacious shell manufacturer from ABS with distinctive front cooling vent which provides excellent air flow & reduced heat built up.
- Fixed with pin-lock which is an easily adjustable, comfortable and user friendly locking system.
- This pin-lock headband which specially designed together with **patented** 8-point moulded **Energy Absorber** suspension system provides essential crown clearance to absorb impact energy.
- Comply to MS183, ANSI Z89.1 & EN397
- 1 pc/polybag 20pcs/carton

TFM11-S5PHPL



Optimus 11 - Push Lock TFM11-S5PHPB

- Ultra modern design & spacious shell manufacturer from ABS with distinctive front cooling vent which provides excellent air flow & reduced heat built up.
- Fixed with **patented** Push-Lock harness which is a useful improvements compare to conventional headband that are easily adjustable to their circumference & comfortably accommodate different head size.
- This Push-Lock headband which specially designed together with **patented** 8-point moulded **Energy Absorber** suspension system provides essential crown clearance to absorb impact energy.
- Comply to MS183, ANSI Z89.1 & EN397 • 1 pc/polybag 20pcs/carton

TFM11-S5PHPB



HEAD PROTECTION

PROGUARD SAFETY PRODUCTS CATALOGUE



TFM11-WHG3PB



Optimus 11 - Push Lock TFM11-WHG3PB

- Ultra modern design & spacious shell manufacturer from ABS with distinctive front cooling vent which provides excellent air flow & reduced heat built up.
- Fixed with **patented** Push-Lock harness which is a useful improvements compare to conventional headband that are easily adjustable to their circumference & comfortably accommodate different head size.
- This Push-Lock headband which specially designed together with **patented** hi-tech 8- point terylene webbing **Energy Absorber** suspension system provides essential crown clearance, comfort & additional protection against impact.
- Comply to MS183, ANSI Z89.1, AS/NZS1801 & EN397
- 1 pc/polybag 20pcs/carton



TFM11-WHG3PL



Optimus 11 - Pin Lock TFM11-WHG3PL

- Ultra modern design & spacious shell manufacturer from ABS with distinctive front cooling vent which provides excellent air flow & reduced heat built up.
- Fixed with unique pin-lock which is an easily adjustable, comfortable and user friendly locking system.
- This pin-lock headband which specially designed together with **patented** hi-tech 8-point terylene webbing **Energy Absorber** suspension system provides essential crown clearance, comfort & additional protection against impact.
- Comply to MS183, ANSI Z89.1, AS/NZS1801 & EN397
- 1 pc/polybag 20pcs/carton



TFM11-WHG3RS

Optimus 11 - Stealth Lock (Ratchet) TFM11-WHG3RS

- Ultra modern design & spacious shell manufacturer from ABS with distinctive front cooling vent which increase air flow & reduced heat built up.
- Fixed with **patented** Stealth-Lock which is an easily adjustable, comfortable and user friendly locking system.
- This ratchet headband which specially designed together with **patented** hi-tech 8-point terylene webbing **Energy Absorber** suspension system provides essential crown clearance, comfort & additional protection against impact.
- Comply to MS183, ANSI Z89.1, AS/NZS1801 & EN397
- 1 pc/polybag 12pcs/carton





Optimus 12 - Slide Lock TFM12-PHSL

- Ultra modern design & spacious shell manufacturer from ABS.
- Fixed with unique slide-lock which is an easily adjustable, comfortable and user friendly locking system.
- This slide-lock headband which specially designed together with **patented** 8-point moulded **Energy Absorber** suspension system provides essential crown clearance to absorb impact energy.
- Comply to MS183, ANSI Z89.1 & EN397
- 1 pc/polybag 40pcs/carton

TFM12-PHSL



Optimus 12 - Pin Lock TFM12-S5PHPL

- Ultra modern design & spacious shell manufacturer from ABS.
- Fixed with pin-lock which is an easily adjustable, comfortable and user friendly locking system.
- This pin-lock headband which specially designed together with **patented** 8-point moulded **Energy Absorber** suspension system provides essential crown clearance to absorb impact energy.
- Comply to MS183, ANSI Z89.1 & EN397
- 1 pc/polybag 20pcs/carton

TFM12-S5PHPL



Optimus 12 - Push Lock TFM12-S5PHPB

- Ultra modern design & spacious shell manufacturer from ABS.
- Fixed with unique Push-Lock harness which is a useful improvements compare to conventional headband that are easily adjustable to their circumference & comfortably accommodate different head size.
- This **patented** Push-Lock headband which specially designed together with **patented** 8-point moulded **Energy Absorber** suspension system provides essential crown clearance to absorb impact energy.
- Comply to MS183, ANSI Z89.1 & EN397 • 1 pc/polybag 20pcs/carton

TFM12-S5PHPB





Optimus 12 - Push Lock TFM12-WHG3PB

- Ultra modern design & spacious shell manufacturer from ABS.
- Fixed with unique Push-Lock harness which is a useful improvements compare to conventional headband that are easily adjustable to their circumference & comfortably accommodate different head size.
- This Push-Lock headband which specially designed together with **patented** hi-tech 8 point terylene webbing **Energy Absorber** suspension system provides essential crown clearance, comfort & additional protection against impact.
- Comply to MS183, ANSI Z89.1, AS/NZS1801 & EN397
- 1 pc/polybag 20pcs/carton

TFM12-WHG3PB



Optimus 12 - Pin Lock TFM12-WHG3PL

- Ultra modern design & spacious shell manufacturer from ABS.
- Fixed with unique pin-lock which is an easily adjustable, comfortable and user friendly locking system.
- This pin-lock headband which specially designed together with **patented** hi-tech 8-point terylene webbing **Energy Absorber** suspension system provides essential crown clearance, comfort & additional protection against impact.
- Comply to MS183, ANSI Z89.1, AS/NZS1801 & EN397
- 1 pc/polybag 20pcs/carton

TFM12-WHG3PL



Optimus 12 - Stealth Lock (Ratchet) TFM12-WHG3RS

- Ultra modern design & spacious shell manufacturer from ABS.
- Fixed with **patented** Stealth-Lock which is an easily adjustable, comfortable and user friendly locking system.
- This ratchet headband which specially designed together with **patented** hi-tech 8 point terylene webbing **Energy Absorber** suspension system provides essential crown clearance, comfort & additional protection against impact.
- Comply to MS183, ANSI Z89.1, AS/NZS1801 & EN397
- 1 pc/polybag 12pcs/carton

TFM12-WHG3RS





Megatron 5 - Pin Lock TFM5-WHG5PL

- Ultra modern design & lightweight shell manufacturer from ABS.
- Fixed with unique pin-lock which is an easily adjustable, comfortable and user friendly locking system.
- This pin-lock headband which specially designed together with **patented** hi-tech 8 point terylene webbing **Energy Absorber** suspension system provides essential crown clearance, comfort & additional protection against impact.
- Comply to EN397
- 1 pc/polybag 20pcs/carton

TFM5-WHG5PL



Megatron 5 - Stealth Lock (Ratchet) TFM5-WHG5RS

- Ultra modern design & lightweight shell manufacturer from ABS.
- Fixed with **patented** Stealth-Lock which is an easily adjustable, comfortable and user friendly locking system.
- This ratchet headband which specially designed together with **patented** 8 point terylene webbing **Energy Absorber** suspension system provides essential crown clearance to absorb impact energy.
- Comply to EN397 • 1 pc/polybag 12pcs/carton

TFM5-WHG5RS



BECKER Economic Protective Helmet - Ratchet EPH-33R

- Economical & extreme lightweight shell manufacturer from HDPE.
- Fixed with **patented** Stealth-Lock which is an easily adjustable, comfortable and user friendly locking system.
- This ratchet headband which specially designed together with 4 point moulded shock absorbing suspension system provides essential crown clearance to absorb impact energy.
- Comply to EN397, ANSI Z89.1
- 1 pc/polybag 12pcs/carton

EPH-33R





BECKER Economic Protective Helmet - Pin Lock EPH-33PL

- Economical & extreme lightweight shell manufacturer from HDPE.
- Fixed with pin-lock which is an easily adjustable, comfortable and user friendly locking system.
- This pin-lock headband which specially designed together with 4 point moulded shock absorbing suspension system provides essential crown clearance to absorb impact energy.
- Comply to EN397, ANSI Z89.1
- 60pcs/carton

EPH-33PL



BC1-WHPL



Prima Vented Bump Cap BC1-WHPL

- Special design shell that combines bump protection with high level of ventilation for wear comfort.
- Fixed with pin-lock which is an easily adjustable, comfortable and user friendly system.
- This pin-lock headband which specially designed with **patented** 4 point terylene webbing **Energy Absorber** suspension system provides essential crown clearance, comfort & additional protection against impact.
- Comply to EN812 • 1 pc/polybag 24pcs/carton



BC1-PHPL



Prima Vented Bump Cap BC1-PHPL

- Special design shell that combines bump protection with high level of ventilation for wear comfort.
- Fixed with pin-lock which is an easily adjustable, comfortable and user friendly system.
- This pin-lock headband which specially designed together with 4 point moulded suspension system provides essential crown clearance & comfort.
- Comply to EN812 • 1 pc/polybag 40pcs/carton





CBC-99NB



HSB-AD123H

Cotton Bump Cap CBC-99NB

- Made of 70% cotton & 30% polyester.
- Foam padding at top of forehead area protects against bump and scraps.
- Velcro tape to easily adjustable head size, comfortable and lightweight.
- 1 pc/polybag

Helmet Sunshade Brim HSB-AD123H

- Made of UV stabilized PE material.
- Provide excellent protection against sun with cotton neck flap.
- Holds shape in hot & wet climates.
- Sold individually.

Custom Printing Services

- Company logos & slogan are always looks great on safety helmets - **Customize your helmet!!!!**
- Your artwork will be sized to fit the imprint area of the specific helmets you order.
- Imprint available on the front, back & side.
- Maximum number of colours and location : 3 colours per hat
- Allows 2 weeks for delivery.



PGCS-CE

Replacement Chin Strap PGCS-CE

- Fits all Proguard's & Ecosafe's helmets.
- Adjustable & keep safety helmets in place in active situation.
- Replaceable for hygiene & comfort.
- Sold individually.



SB2

Replacement Sweatband SB2

- Fits all Proguard's & Ecosafe's helmet and bump caps harness.
- Replaceable for hygiene & comfort.
- Absorb sweat & prevents perspiration build-up.
- Sold individually.



CS-BC-CE

Replacement Bump Cap Chin Strap CS-BC-CE

- Fits Proguard's Bump Cap.
- Adjustable & keep safety helmets in place in active situation.
- Replaceable for hygiene & comfort.
- Sold individually.





PHSL



PHPL

Helmet Replacement Plastic Harness PHSL

- 8 point plastic harness slide-lock to suit Proguard's Safety Helmets model HG1, HG2 & HG3.
- Lightweight replacement harness & cost effective solution.
- Sold individually.

Helmet Replacement Plastic Harness PHPL

- 8 point plastic harness pin-lock to suit Proguard's Safety Helmets model HG1, HG2 & HG3.
- Lightweight replacement harness & cost effective solution.
- Sold individually.



WHG3PL

Helmet Replacement Webbing Harness WHG3PL

- 8 point terylene webbing harness pin-lock to suit Proguard's Safety Helmets model HG1, HG2 & HG3.
- Lightweight replacement harness & cost effective solution.
- Sold individually.

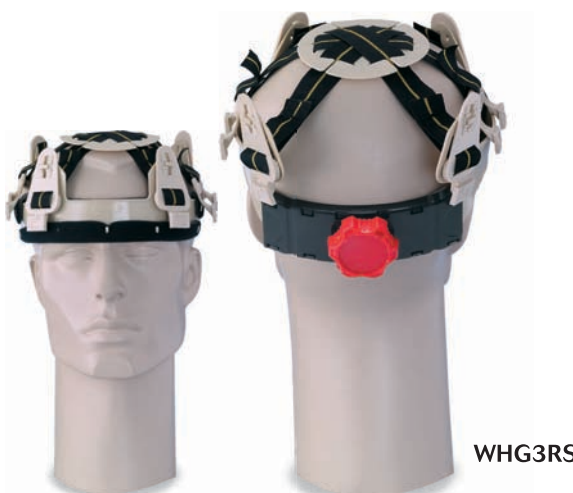

WHG3RS

Helmet Replacement Ratchet Harness WHG3RS

- 8 point terylene webbing ratchet harness to suit Proguard's Safety Helmets model HG1, HG2 & HG3.
- Lightweight replacement harness & cost effective solution.
- Sold individually.



EA2 TH/H4PL

Helmet Replacement Webbing Harness EA2 TH/H4PL

- 8 point patented terylene webbing **Energy Absorber** harness pin-lock to suit Proguard's Safety Helmet model: TFM 11 & TFM 12
- Lightweight replacement harness & cost effective solution.
- Sold individually.





EA2 TH/H4PB



EA2 TH/H4RS

Helmet Replacement Webbing Harness EA2 TH/H4PB

- 8 point **patented** terylene webbing **Energy Absorber** harness pin-lock to suit Proguard's Safety Helmets model: TFM 11 & TFM 12
- Lightweight replacement harness & cost effective solution.
- Sold individually.

Helmet Replacement Ratchet Harness EA2 TH/H4RS

- 8 point **patented** terylene webbing **Energy Absorber** ratchet harness to suit Proguard's Safety Helmets model: TFM 11 & TFM 12
- Lightweight replacement harness & cost effective solution.
- Sold individually.



S5-PHPB



S5-PHPL

Helmet Replacement Plastic Harness S5-PHPB

- **Patented** 8 point moulded **Energy Absorber** plastic harness Push-lock to suit Proguard's Safety Helmets model HG1, HG2, HG3, TFM11 & TFM12
- Lightweight replacement harness & cost effective solution.
- Sold individually.

Helmet Replacement Plastic Harness S5-PHPL

- **Patented** 8 point moulded **Energy Absorber** plastic harness pin-lock to suit Proguard's Safety Helmets model TFM 11 & TFM 12
- Lightweight replacement harness & cost effective solution.
- Sold individually.





CE
EN166
ANSI Z87.1



A2

CE
EN166
ANSI Z87.1



A3

Helmet Visor Carrier A2

- Fully Hi-impact ABS construction, stylist designed with spring coil for easily fits to various safety helmets or hardhats.
- Positive stop hinge which automatically hold visor in raised position.
- Durable & ideal choice for excellent face protection.
- Comply to EN166-B & ANSI Z87.1
- 1 pc/polybag 20pcs/box 4box/carton

Helmet Visor Carrier A3

- Half ABS & half aluminium construction, basic designed with spring coil for easily fits to various safety helmets.
- Positive stop hinge which automatically hold visor in raised position.
- Medium Duty & ideal choice for excellent face protection.
- Comply to EN166-B & ANSI Z87.1
- 1 pc/polybag 25pcs/box 4box/carton

CE
EN166
ANSI Z87.1



A4

ANSI Z87.1



CM-HBV6

Helmet Visor Carrier A4

- Fully aluminium construction, basic designed with spring coil for easily fits to various safety helmets.
- Positive stop hinge which automatically hold visor in raised position.
- Heavy Duty & ideal choice for excellent face protection.
- Comply to EN166-B & ANSI Z87.1
- 1 pc/polybag 25pcs/box 4box/carton

Economic Helmet Visor Carrier CM-HBV6

- Fully ABS construction, basic designed with spring coil for easily fits to various safety helmets.
- Positive stop hinge which automatically hold visor in raised position.
- Economical & ideal choice for excellent face protection
- Comply ANSI Z87.1
- 1 pc/polybag 20pcs/box 4box/carton





CE
EN166
ANSI Z87.1
VH4-CE



ANSI Z87.1
EVH-1

Faceshield- Browguard Holder VH4-CE

- Most elegant visor holder which eliminates face & forehead injury.
- Lightweight & comfortable with adjustable pinlock for height adjustment & ratchet locking system.
- With rounded shape side tension knobs allows flip-up visor to be positioned as user wishes.
- Durable & ideal choice for excellent face protection.
- Can be fitted with all FC48 & SV1 series visors.
- Comply to EN166-B & ANSI Z87.1
 - 10pcs/box 4box/carton

Economic Visor Holder EVH-1

- Economic visor holder which eliminates face & forehead injury.
- Lightweight & comfortable with adjustable slidelock for height adjustment & ratchet locking system.
- With rounded shape side tension knobs allows flip-up visor to be positioned as user wishes.
- Durable & ideal choice for excellent face protection.
- Can be fitted with all FC48 & SV1 series visors.
- Comply to ANSI Z87.1
 - 10pcs/box 4box/carton



CE
EN166
ANSI Z87.1

BGVH/SI-1



BGVH

CE
EN166
ANSI Z87.1

Helmet Visor Carrier BGVH/SI-1/SI-2

- Lightweight & user friendly helmet visor carrier.
- Easy toggle fastening system for securing visor.
- Plug-in system to attach the carrier onto Proguard's safety helmet. Multiple slots available for all Proguard helmet models.
- Can be fitted with all FC48 & SV1 series visors.
- Comply to EN166-B & ANSI Z87.1
- 1pc/polybag 10pcs/box



CE
EN166
ANSI Z87.1

BGVH/SI-2





Replacement Cylinder Visor FC48C-CE

- Classic cylinder shape polycarbonate visor which provide excellent protection against impact, flying particles, liquid splash, molten metal and hot solids.
- Suitable for most application including electrical hazard environment.
- Universal slot to fit various types of holders & browguard.
- Comply to EN166-1 B & ANSI Z87.1
- 1 pc/polybag 50pcs/carton

CE
EN166
ANSI Z87.1
FC48C-CE

Replacement Cylinder Visor FC48G5-CE

- Classic cylinder shape polycarbonate visor which provide excellent protection against impact, flying particles, liquid splash, molten metal and hot solids.
- Suitable for most application including electrical hazard environment.
- Shaded for anti-glare, brazing & light cutting operation purposes.
- Universal slot to fit various types of visor holders & browguard.
- Comply to EN166-1 B & ANSI Z87.1
- 1 pc/polybag 50pcs/carton



CE
EN166
ANSI Z87.1
FC48G5-CE

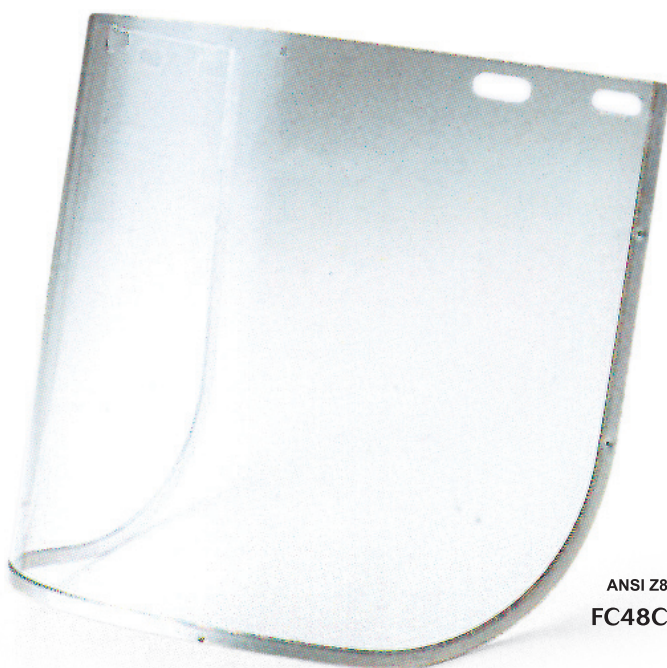

ANSI Z87.1
FC48C-AL

Economic Replacement Visor FC48C-AL

- 1.0mm Polycarbonate visor with aluminium bound which provide ample protection against impact, flying particles, liquid splash, molten metal and hot solids.
- Universal slot to fit various types of visor holders & browguard.
- Comply to ANSI Z87.1
- 1 pc/polybag 35pcs/box 4box/carton





Replacement Spherical Visor SVI-1-CE

- Stylist spherical shape polycarbonate visor which provide excellent protection against impact, flying particles, liquid splash, molten metal and hot solids.
- Suitable for most application including electrical hazard environment.
- Universal slot to fit various types of visor holders & browguard.
- Comply to EN166-1 B & ANSI Z87.1
- 1pc/polybag 50pcs/carton



CE
EN166
ANSI Z87.1
SVI-1-CE



CE
EN166
ANSI Z87.1
SVI-S5-CE
(Anti-fog)

Replacement Cylinder Visor SVI-S5-CE

- Stylist spherical shape polycarbonate visor which provide excellent protection against impact, flying particles, liquid splash, molten metal and hot solids.
- Suitable for most application including electrical hazard environment.
- Shaded for anti-glare, brazing & light cutting operation purposes.
- Universal slot to fit various types of visor holders & browguard.
- Comply to EN166-1 B & ANSI Z87.1
- 1pc/polybag 50pcs/carton



CE
EN1731
ANSI Z87.1
FC48SM

Replacement Mesh Visor FC48SM

- Protection against flying branches & woodchips during forestry operation.
- This design provides excellent sturdiness.
- Universal slot to fit various types of visor holders & browguard.
- Comply to EN1731
- 1pc/polybag 50pcs/carton





CE
EN166
ANSI Z87.1

LF-WH24



CE
EN166
ANSI Z87.1

FL-HHS24

Economic Welding Head Shield LF-WH24

- These welding shields are fitted with ratchet adjustable headgear to fits various head size.
- Provides extra coverage from weld spatter and radiation plus aerodynamically contoured to offer superior welding fume deflection.
- Designed specifically for welders comfort, versatility & performance.
- Comply to ANSI Z87.1
- Sold individually. 35pcs/carton

Economic Welding Hand Shield FL-HHS24

- These hand-held shield provides the same protection as the welding helmet, but is held in position by the handle. This type of shield is frequently used by a person who welds for a short period of time.
- Provides good coverage from weld spatter and radiation plus offer superior welding fume deflection.
- Comply to ANSI Z87.1
- Sold individually. 50pcs/carton



WH4000



WH4500



WH6000

Auto Darkening Helmet WH4000

Light state: DIN4
Dark state: DIN9-13 (Stepless Adjustment)
Switching time: < 1/10,000s at room temperature
Delay time: slow/ fast:0.15s~0.80s
Sensitivity: Low/High
Battery: Li-Mi & Solar Combination
(Min. Lifetime: 5,000 Welding Hours)
Viewing area: 92 x 42 mm
Cartridge Size : 110 x 90 x 10 mm
Weight: 430G
Material of helmet: P/P
1pc/box 6pcs/carton

Auto Darkening Helmet WH4500

Light state: DIN4
Dark state: DIN9-13 (Stepless Adjustment)
Switching time: < 1/10,000s at room temperature
Delay time: slow/ fast:0.15s~0.80s
Sensitivity: Low/High
Battery: Li-Mi & Solar Combination
(Min. Lifetime: 5,000 Welding Hours)
Viewing area: 92 x 42 mm
Cartridge Size : 110 x 90 x 10 mm
Weight: 475G
Material of helmet: NYLON
1 pc/box 6pcs/carton

Auto Darkening Helmet WH6000

Light state: DIN4
Dark state: DIN9-13(Stepless Adjustment)
Switching time: < 1/25,000S at Room Temperature
Delay time: slow/Fast 0.15S-0.80S
Sensitivity: Low/High
Battery: Li-Mi & Solar Combination
(Min. Lifetime: 5,000 Welding Hours)
Viewing area: 98 X 43 MM
Cartridge Size : 110 X 90 X 10 MM
Weight: 475G
Material of helmet: NYLON
1pc/box 6pcs/carton





CM-WS68

Economic Welding Helmet Shield CM-WS68

- Simple and lightweight welding shield which is durability, resistant to heat and weld spatter.
- Flip up front lens for easy welding inspection.
- Universal slot to fit various types of visor holders & browguard.
- Sold individually 50pcs/carton



CE
EN166
ANSI Z87.1

PC-7888

Impact Resistant Replacement Welding Clear Lenses

PC-7888

- Moulded polycarbonate lens with optical quality finishes.
- Provides excellent impact & ultra-violets rays protection.
- Welding spatter is minimized by these replacement lenses which protect the welding filter lens.
- Fits perfectly to numerous brands of welding helmets & shield.
- Comply to ANSI Z87.1
- 80 pcs/box 10box/carton

CE
EN166
ANSI Z87.1



24DWL

Replacement Welding Dark Lenses 24DWL

- 2" x 4 1/4" Rectangular welding glass filters with superior optical properties.
- These lenses are designed to prevent flash burns and eye damage by absorption of the infrared and ultraviolet rays produced by the arc.
- Fits perfectly to numerous brands of welding helmets & shields.
- Available in shade S5, S10 & S11
- Comply to ANSI Z87.1
- 100pcs/box 5box/carton

Replacement Welding Dark Lenses 34DWL

- 3" x 4 1/4" Rectangular welding glass filters with superior optical properties.
- These lenses are designed to prevent flash burns and eye damage by absorption of the infrared and ultraviolet rays produced by the arc.
- Fits perfectly to numerous brands of welding helmets & shields.
- Available in shade S11 only.
- Comply to ANSI Z87.1
- 100pcs/box 4box/carton

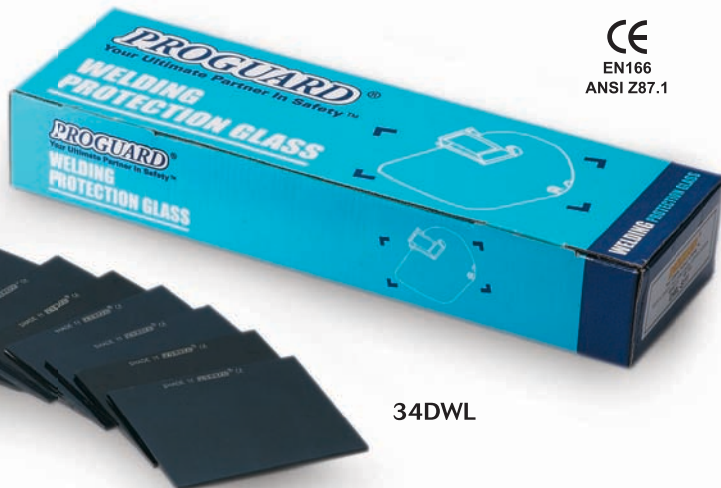

CE
EN166
ANSI Z87.1

34DWL



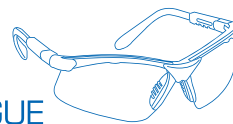

CE
EN166
ANSI Z87.1



Genex-BS



Genex-BC



Genex-BIO

Genex Safety Eyewear BC/BS/BIO

- Four point ratchet temple fit virtually with any type of faces.
- Frame support behind lens provides added durability plus light weight for extreme comfort.
- Adjustable angle & length on the temples plus finger-tip nose-piece offer more customary and flexible fit.
- Full wrap around with 8.25 curved lenses provide more coverage and with the distraction of seams.
- High impact resistant lenses with anti-scratch properties.
- Comply to ANSI Z87.1 & EN166
- 1pr/polybag 12pairs/box 25box/carton

CE
EN166
ANSI Z87.1



Prolgnite-BYS



Prolgnite-BYC



Prolgnite-BYCM



Prolgnite-BYIO

Prolgnite Safety Eyewear BYC/BYS/BYCM/BYIO

- Incredibly light & fashionable design resemble sunglasses.
- Close fitting, unitary front with dual 9 base curved lenses which offer wide & unobstructed vision.
- Sleek design features silky and rubberized coating on nylon temple.
- Soft, Flexible earpiece and nose piece provide extra comfort & protects against slippage.
- One piece polycarbonate lens design offers wide viewing areas.
- High Impact resistant lenses with anti-scratch properties.
- Comply to ANSI Z87.1 & EN166
- 1pr/polybag 12pairs/box 25box/carton

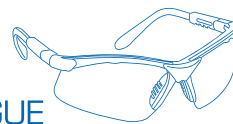

ANSI Z87.1



315BM



176IO



316S

IRIS Safety Eyewear 315BM/316S/176IO

- Incredibly lightweight.
- Ultra modern design & stylist.
- Unique dual lens give maximum protection, safety, durability & comfort for greater user acceptance.
- High impact resistant lenses with anti-scratch properties.
- Soft, flexible earpiece and provide extra comfort & protects against slippage.
- Comply to ANSI Z87.1

• 1pr/polybag 12pairs/box 25box/carton

CE
EN166
ANSI Z87.1



2420



2422SM



2421

Concept Safety Eyewear 2420/2421/2422SM

- This trend-setter surpasses even the coolest eyewear styles, helping to ensure worker compliance.
- Incredibly light eyewear with superior impact protection.
- Soft, pliable temples and a fingertip nosepiece offer long-wearing comfort.
- Snug and comfortable fit; helps minimize slippage and provides full brow protection.
- Size and style is popular with both men and women.
- Scratch-resistant, hardcoated 100% polycarbonate lens.
- Comply to ANSI Z87.1 & EN166

• 1pr/polybag 12pairs/box 25box/carton

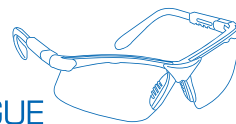

CE
EN166
ANSI Z87.1



Medallas MMC
(Anti-fog)



Medallas MMS
(Anti-fog)



Medallas MBUS
(Anti-fog)



Medallas MBUC
(Anti-fog)

Medallas Safety Eyewear MMC/MMS/MBUC/MBUS

- Incredibly lightweight.
- Ultra modern design & stylist.
- Unique dual lens give maximum protection, safety, durability & comfort for greater user acceptance.
- High impact resistant lenses with anti-scratch & anti-fog properties.
- Extendable side arm contoured for perfect fit & comfort.
- Comply to ANSI Z87.1 & EN166
- 1pr/polybag 12pairs/box 25box/carton

Crusader Safety Eyewear Crusader-C/S

- Incredibly lightweight.
- Sleek design with superior coverage.
- Unique dual lens give maximum protection, safety, durability & comfort for greater user acceptance.
- High impact resistant lenses with anti-scratch & anti-fog properties.
- Extendable side arm contoured for perfect fit & comfort.
- Filter more than 99% of UV-A & UV-B lights.
- Comply to ANSI Z87.1 & EN166
- 1pr/polybag 12pairs/box 25box/carton



Crusader-C
(Anti-fog)



Crusader-S
(Anti-fog)

CE
EN166
ANSI Z87.1

Responder Safety Eyewear Responder-C/S

- Extremely lightweight eyewear with superior optics properties.
- All around impact protection.
- Popular design resemble sunglasses; fits men & women snugly to prevents slippage.
- Revolutionary dual 9.75 base curvature in an integral unitary lens offer wide & unobstructed view.
- Deep temples provide same protection as large side-shield.
- High impact resistant lenses with anti-scratch & anti-fog properties.
- Filter more than 99% of UV-A & UV-B lights.
- Comply to ANSI Z87.1 & EN166
- 1pr/polybag 12pairs/box 25box/carton



Responder-C
(Anti-fog)



Responder-S
(Anti-fog)

CE
EN166
ANSI Z87.1

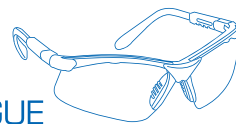

CE
EN166
ANSI Z87.1



460M
Indoor/outdoor lens



461M
Smoke red mirror lens



466M
Brown gold mirror lens



467M
Smoke gold mirror lens



468M
Smoke silver mirror lens



469M
Smoke blue mirror lens



4683
Hard-coated smoke lens



4675
Hard-coated amber lens



4680
Hard-coated clear lens

Starlite Safety Eyewear

- Extremely lightweight eyewear with superior optics properties.
- All around impact protection.
- Popular design resemble sunglasses; fits men & women snugly to prevents slippage.
- Deep temples provide same protection as large side-shield.
- Revolutionary dual 9.75 base curvature in an integral unitary lens offer wide & unobstructed view.
- High impact resistant lenses with anti-scratch.
- Economically priced.
- Comply to ANSI Z87.1 & EN166
- 1pr/polybag 12pairs/box 25box/carton



4686
Hard-coated brown lens

Sector 5 Safety Eyewear S5BC/S5BS/S5BUV

- Extremely lightweight.
- Ultra modern design with ergonomically designed nose bridge for maximum comfort.
- Uninterrupted lateral vision thanks to a single wide panoramic lens.
- High Impact resistant lenses with anti-scratch properties.
- Excellent UV protection.
- Comply to ANSI Z87.1 & EN166
- 1pr/polybag 12pairs/box 25box/carton



S5BS



S5BUV

CE
EN166
ANSI Z87.1



S5BC

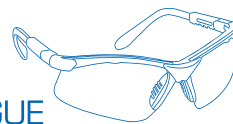

CE
EN166
ANSI Z87.1



Serpent-C
Clear lens



Serpent-SSM
Smoke silver mirror lens

Serpent Safety Eyewear

- Incredibly lightweight eyewear with superior impact protection.
- Unique dual lens in a single piece lens design gives maximum protection safety, durability & comfort for greater user acceptance.
- Soft rubber earpiece & nosepiece provide long-wearing comfort & protects against slippage.
- Comply to ANSI Z87.1 & EN 166
- 1pr/polybag 12pairs/box 25box/carton



Serpent-IO
Indoor/ Outdoor lens

CE
EN166
ANSI Z87.1



Cobra-AFC
Anti-fog clear lens

Cobra Safety Eyewear

- Extremely lightweight eyewear with superior optics properties.
- High impact resistant lenses with anti-scratch & anti-fog properties.
- Soft rubber earpiece & nosepiece provide long-wearing comfort & protects against slippage.
- Comply to ANSI Z87.1 & EN 166
- 1pr/polybag 12pairs/box 25box/carton

CE
EN166
ANSI Z87.1



Viper-SSM
Smoke silver mirror lens



Viper-C
Clear lens

Viper Safety Eyewear

- Incredibly lightweight frame with latest double injection technology.
- Ultra modern design & stylist.
- Unique dual lens give maximum protection, safety, durability & comfort for greater user acceptance.
- Soft rubber nosepiece provides long-wearing comfort.
- Sleek design features smooth and rubberized temple.
- High impact resistant lenses with anti-scratch properties.
- Comply to ANSI Z87.1 & EN 166
- 1pr/polybag 12pairs/box 25box/carton



Viper-IO
Indoor/ Outdoor lens

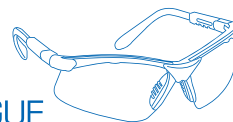

CE
EN166
ANSI Z87.1



46YS



46YC



46BC



46BS



46BUC



46BUS

Series 46 Safety Eyewear yc/ys/bc/bs/buc/bus

- Extremely lightweight.
- Uninterrupted lateral vision in a single wide panorama lens.
- Frame material made of high impact polyamide.
- High impact resistant lenses with anti-scratch properties.
- Excellent UV protection.
- Comply to ANSI Z87.1 & EN166
- 1pr/polybag 12pairs/box 25box/carton

CE
EN166
ANSI Z87.1



VS-2000C



VS-2000C Galaxy



VS-2000A



VS-2000S

Series 2000 Visitor Safety Spectacles

2000C/2000C Galaxy/2000A/2000G/2000S

- Lightweight & inexpensive – makes a great visitor spectacles.
- Warp around side shield with ventilation temple for maximum protection.
- High impact resistant lens.
- Can be wear over description glasses.
- Comply to ANSI Z87.1 & EN166
- 1pr/polybag 12pairs/box 25box/carton



VS-2000G

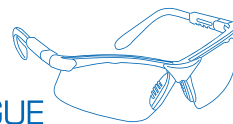

CE
EN166
ANSI Z87.1

Classix-AF (Anti-fog)



CE
EN166
ANSI Z87.1

Classix

Classix & Classix AF Safety Chemical Goggle

Classix/Classix-AF

- Unimpeded side vision.
- High impact resistant lenses with excellent optical properties.
- Comfortable adjustable headband with improved ventilation system.
- Snug, yet pressure fit and fits perfectly over prescription glasses.
- Available with or without anti-fog lens.
- Comply to ANSI Z87.1 & EN166
- 1pr/polybag 12pairs/box 12box/carton



CE
EN166
ANSI Z87.1

WG-209

Welding Goggle WG-209/225

- Close fit of the tinted goggle frame provides good comfort.
- Offer excellent protection against impact when the welding filters are in an upright position.
- Comfortable adjustable headband with improved ventilation system.
- Welding goggle with flip-up mechanism.
- Fits perfectly over prescription glasses.
- Available with dual or single piece lens.
- Comply to ANSI Z87.1 & EN166
- 1pr/box 24prs/carton



CE
EN166
ANSI Z87.1

WG-225

Spectacles Cord SC29ELB/ELY

- Economically priced and is a highly versatile retainer that can be worn with virtually any spectacle.
- 100% polyester material.
- Ultra thin design is light & comfortable.
- 12pcs/polybag



SC29ELB

SC29ELY



BSP-ZC

Spectacles Pouch BSP-ZC

- Stylish black pouch carriers and protect spectacles from scratches.
- An ideal way to keep & store your spectacles when not in use.
- Made from nylon dinear material with zipper closure and belt loop.
- Sold individually 1pc/polybag

HEARING PROTECTION

PROGUARD SAFETY PRODUCTS CATALOGUE

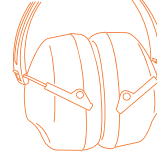

CE
EN352-1
EN166

CE
EN352-3
SNR: 29dB



PC03SE*



BGVH/SI-2/PC03SE*



BGVH/SI-1/PC03SE*

CE
EN352-3
SNR: 29dB



PC06SE*



BGVH/SI-1/PC06SE*

CE
EN352-1
EN166



BGVH/SI-2/PC06SE*



BGVH/SI-1 S5/PC06SE*

Helmet Slotted Earmuff PC03SE / PC06SE / BGVH-SI 1-PC03SE / BGVH-SI 2-PC03SE

- Lightweight, comfortable helmet mounted earmuff that deliver a high attenuation level performance to address the most difficult noise situation.
- These slotted earmuffs can be use with a wide range of safety helmets.
- Earmuff cups should snap in place during use & swing back when not in use.
- PC03SE & PC06SE can be perfectly fitted with Safety Helmet, Helmet Visor Carrier BGVH with Series FC48 or Series SV-1 visors to provide complete head, face and hearing protection.
- SNR: 29dB
- Comply to EN352-3
- 1pr/box 24prs/carton

* Helmet excluded

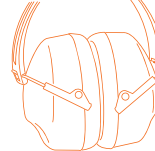

CE
EN352-1
SNR: 27dB



A-606-Y



A-606-R



A-606-B

VITO Earmuff A-606-Y/R/B

- This lightweight earmuff with soft foam-filled cushions provides a good seal for protection against harmful noise & sound.
- Adjustable contoured headband with soft pad provides comfortable fit and all round protection for both short & long spell exposure.
- Can be worn in three positions.
- SNR: 27dB
- Comply to EN352-1, JKKP EM 146/04
- 1pr/box 20prs/carton

CE
EN352-1
SNR: 22dB



A-609-B



A-609-BLK



A-609-R

ECO Earmuff A-609-BLK/B/R

- This comfortable earmuff offer quality noise reduction at a affordable price.
- Extremely lightweight, non-conductive plastic construction and fully adjustable contoured headband for user comfort.
- Pivoting cup attachment for equal pressure distribution.
- Can be worn in three positions.
- SNR: 22dB
- Comply to EN352-1, JKKP EM 151/04
- 1pr/box 20prs/carton

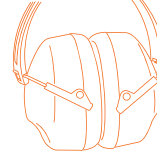

CE
EN352-1
SNR: 29dB



PC-03EM

INFINITY Earmuff PC-03EM

- Padded headband allows easy adjustment to fits most head size comfortably.
- Soft, foam padded ear cups allows a comfortable fit even when wearing safety eyewear.
- Rugged construction provides durability in wide range of environments.
- Lightweight for long wearing comfort.
- Can be worn in three positions.
- SNR: 29dB
- Comply to EN352-1

• 1pr/polybag

25prs/carton

CE
EN352-1
SNR: 30dB



EM-918-GR

MILLENNIUM Earmuff EM-918-GR/B

- This earmuff gets high rating for superior comfort & secure fit with high attenuation making it extremely functional.
- Soft foam-filled cushions provide a good seal for protection against harmful noise & sound.
- Ensures protection at both high and low frequencies.
- Can be worn in three positions.
- SNR: 30dB
- Comply to EN352-1, JKKP EM 151/04
- 1pr/box 20prs/carton



EM-918-B



EM-106

CE
EN352-1
SNR: 27dB

PHANTOM Earmuff EM-106

- Provide optimum comfort with excellent protection.
- Padded headband allows easy adjustment to fit most head sizes comfortably.
- Folds up to a compact size for easy storage.
- Soft foam padded ear cups give comfortable fit even when wearing safety eyewear.
- Provides excellent sealing properties, good fit & low surface pressure.
- Designed for intermittent noise and those who frequently enter & exit high noise environment.
- SNR: 27dB
- Comply to EN352-1, JKKP EM 147/04
- 1pr/box 20prs/carton

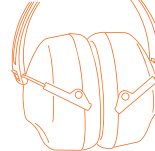

QUANTUM Earmuff EM-105

- Premium features in an affordable earmuff.
- Padded headband allows easy adjustment to fit most head sizes comfortably.
- Soft foam padded ear cups give comfortable fit even when wearing safety eyewear.
- Rugged construction provides durability in a wide range of environments.
- Lightweight for long wearing comfort.
- SNR: 28dB
- Comply to EN352-1, JKKP EM 148/04
- 1pr/box 20prs/carton

CE
EN352-1
SNR: 27dB



EM-105



(Folding position)

CE
EN352-1
SNR: 32dB
PC05FEM

ULTRA Foldable Earmuff PC05FEM

- Provide optimum comfort with excellent protection, excellent sealing properties, good fit & low surface pressure.
- Designed for intermittent noise and those who frequently enter & exit high noise environment.
- Super compact size and folding capabilities makes these earmuffs convenient to store anywhere when not in use.
- SNR: 32dB
- Comply to EN352-1
- 1pr/box 20prs/carton

SQUARO Foldable Earmuff PC08FEM

- Provide optimum comfort with excellent protection, excellent sealing properties, good fit & low surface pressure.
- Padded headband allows easy adjustment to fit most head sizes comfortably.
- Designed for intermittent noise and those who frequently enter & exit high noise environment.
- Super compact size and folding capabilities makes these earmuffs convenient to store anywhere when not in use.
- SNR: 32dB
- Comply to EN352-1
- 1pr/box 20prs/carton

CE
EN352-1
SNR: 32dB

(Folding position)



PC08FEM

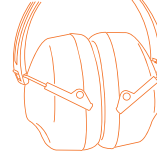

Economic Foldable Earmuff BK816-21R/Y

- Soft foam-filled cushion fits comfortably, folding headband, lightweight provides a good seal for greater comfort & protection against harmful noise.
 - Folds into compact unit for easy storage.
 - Laboratory tested NRR 19dB
- 1pr/box 50prs/carton



BK816-21R



BK816-21Y



BK817-22R

Economic Foldable Earmuff BK817-22R/Y

- Soft foam-filled cushion with deep ear cups, folding headband, lightweight provides a good seal for greater comfort & protection against harmful noise.
- Snug and comfortable fit.
- Folds into compact unit for easy storage.
- Laboratory tested NRR 19dB
- 1pr/box 50prs/carton



BK817-22Y

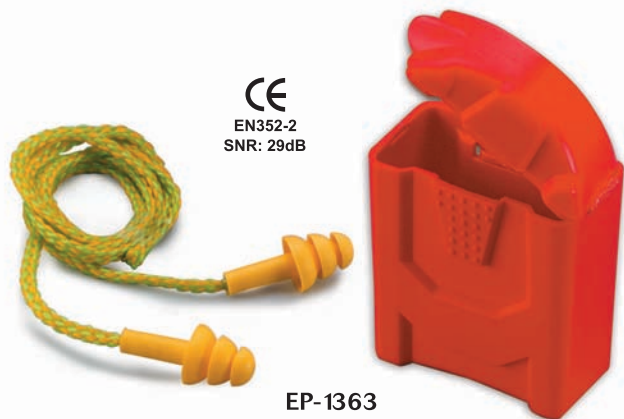

CE
EN352-2
SNR: 29dB

EP-1363



CE
EN352-2
SNR: 29dB

EP-1366

Reusable Earplugs EP-1363/1366

- Excellent protection, convenience and ease of use with great value of reusability.
- Featuring the most comfort and highest noise reduction rating earplug ever.
- These reusable earplugs are generally priced, can be sterilized and easily cleaned with mild soap and water for months of use.
- Made of soft silicone material.
- Each pair comes with a cord and is supplied with a storage case or a polybag.
- SNR: 29dB
- Comply to EN352-2
- EP1363: 100prs/box 12box/carton
- EP1366: 200prs/box 12box/carton



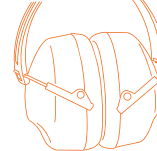

Reusable Earplugs CONIE 1/ 3

- These special yellow colour shape earplug make insertion quick and easy for custom fit & superb comfort.
- Economical, reusable and non-allergenic for user comfort and convenience.
- Can be sterilized and easily cleaned with mild soap and water for months of use.
- Made of soft silicone material.
- Each pair comes with a cord and is supplied with a storage case or a polybag.
- SNR: 21dB
- Comply to EN352-2, JKPP EP 87/04 & JKPP EP 88/04
- Conie 1: 100prs/box 12box/carton
- Conie 3: 200prs/box 12box/carton



CONIE 1

CE
EN352-2
SNR: 21dB

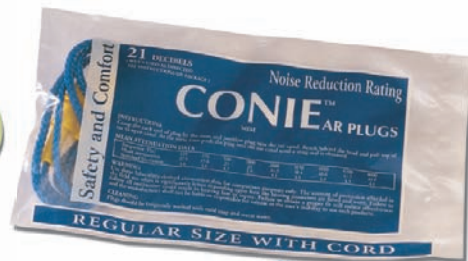

CONIE 3

CE
EN352-2
SNR: 21dB

Reusable Earplugs CONIE 1-OR/ 3-OR

- These special orange colour shape earplug make insertion quick and easy for custom fit & superb comfort.
- Economical, reusable and non-allergenic for user comfort and convenience.
- Can be sterilized and easily cleaned with mild soap and water for months of use.
- Made of soft silicone material.
- Each pair comes with a cord and is supplied with a storage case or a polybag.
- SNR: 21dB
- Comply to EN352-2, JKPP EP 87/04 & JKPP EP 88/04
- Conie 1-OR: 100prs/box 12box/carton
- Conie 3-OR: 200prs/box 12box/carton



CONIE 1-OR

CE
EN352-2
SNR: 21dB



CONIE 3-OR

CE
EN352-2
SNR: 21dB



CONIE 8

CE
EN352-2
SNR: 23dB



CONIE 6

CE
EN352-2
SNR: 23dB

Reusable Earplugs CONIE 6/ 8

- Good protection, convenience and ease of use with extra value of reusability.
- Featuring the most comfort and highest noise reduction rating earplug.
- These reusable earplugs are also economical, can be sterilized and easily cleaned with mild soap and water for months of use.
- Made of soft silicone material.
- Each pair comes with a cord and is supplied with a storage case or a polybag.
- SNR: 23dB
- Comply to EN352-2, JKPP EP 89/04 & JKPP EP 90/04
- Conie 6: 100prs/box 12box/carton
- Conie 8: 200prs/box 12box/carton

3M Reusable Earplugs 3M 1270/1271

- These washable, reusable earplugs have triple flanged design to securely fit the ear canal and provide reliable protection.
- Each pair comes with a cord and is supplied with a storage case or a polybag.
- NRR 25dB
- JKPP EP76/00 & JKPP EP77/00
- 1270: 100prs/box 4box/carton
- 1271: 50prs/box 4box/carton



3M 1271



3M 1270

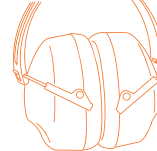

Disposable Foam Earplugs with Dispenser Bottle FEP-03D



- Specification as per FEP-03
- These earplug dispenser bottles are a great way to keep the foam ear plugs you need conveniently at hand.
- These bottles contain unwrapped foam earplugs, which can be easily and hygienically dispensed right into the palm of your hand. Ideal for industrial work areas and workshops!
- Since the ear plugs aren't individually wrapped, dispenser bottles is safe time and reduce waste with no plastic packages to throw away.
- These dispensers can be refilled, making them easy to use, easy to replace, and cost-effective.
- SNR 37dB
- Comply to EN352-2, JKKP EP91/04
- Sold individually 1unit/box
- Refill available

CE
EN352-2
SNR: 37dB
FEP-03D



340 4002



340 4004

AEARO Reusable Earplugs 340 4002/4004

- No sizing is required for these patented, pre-moulded, triple flanged earplugs.
- They are comfortable, hygienic and reusable.
- Each pair comes with a cord and is supplied with a storage case or a polybag.
- NRR 25dB
- JKKP EP35
- 340 4002: 50prs/box 4box/carton
- 340 4004: 100prs/box 4box/carton



CE
EN352-2
SNR: 37dB

Disposable Foam Earplugs FEP-03/03C

- These soft, smooth, taper foam earplugs are moulded for maximum comfort and provide excellent noise reduction.
- Bright orange colour for better visibility.
- Low pressure foam provides all-day comfort and secure fit in a wide range of ear canal sizes.
- Dermatological safe & non-irritating.
- Available in uncorded or corded
- SNR 37dB
- Comply to EN352-2, JKKP EP91/04 & JKKP EP92/04
- 200prs/box 20box/carton



CE
EN352-2
SNR: 37dB
FEP-03

FEP-03C

3M Disposable Foam Earplugs 3M 1100/1110

- Plugs are made of soft foam that expands to fit virtually any size ear canal.
- Comfortable to wear for extended periods.
- Each pair is individually packaged in a plastic bag.
- Available in uncorded or corded.
- NRR 29dB
- JKKP EP55/05 & JKKP EP56/05
- 1100: 200prs/box 5box/carton
- 1110: 100prs/box 5box/carton

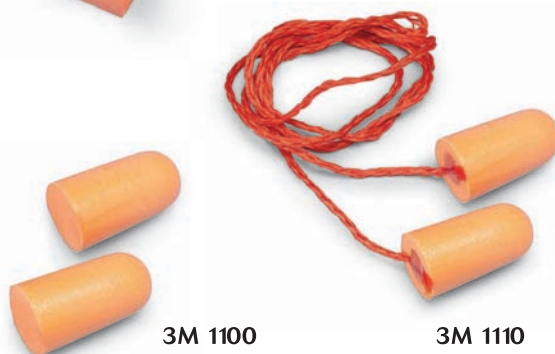

3M 1100

3M 1110



Economy Filter Mask A610-5Y & A610-5B

- PE frame covered by polyester filter media.
- Extremely lightweight, comfortable & economical against non-toxic & large dust.
- Available in two various colours; blue & yellow.
- 1 pc/polybag 100 pcs/carton

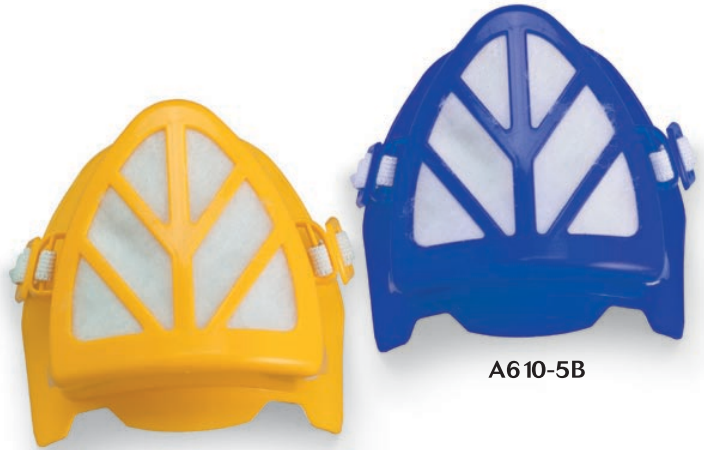

A610-5Y

A610-5B



SFM-3P-T

Tie-on Surgical Face Mask SFM-3P-T

- Made of soft non-glass high filtration material.
- Form-fit design which helps to breathe easier.
- Fluid resistant and approved for medical & general-purpose uses.
- Tie-on 3-ply surgical mask with horizontal ties.
- Lightweight, three-layer construction is comfortable to wear.
- Designed to fit a variety of facial shapes and sizes.
- Manufactured according to OSHA guidelines.
- 50 pcs/box 20 boxes/carton

Ear-loop Surgical Face Mask SFM-3P-EL

- Made of soft non-glass high filtration material.
- Form-fit design which helps to breathe easier.
- Fluid resistant and approved for medical & general-purpose uses.
- 3-ply Surgical mask with elastic ear-loops.
- Lightweight, three-layer construction is comfortable to wear.
- Designed to fit a variety of facial shapes and sizes.
- Manufactured according to OSHA guidelines.
- 50 pcs/box 20 boxes/carton



SFM-3P-EL



DDM-STD

Disposable Dust Mask DDM-STD

- Made of soft non-irritating woven fiber.
- Aluminium nose-piece can be moulded to individual comfort & seal.
- Contoured shape for extra comfort with large filter area, which allows cool and easy breathing.
- 50 pcs/box 20 boxes/carton



Particulate Respirator F313

- FFP1 rating offering protection from solid and liquid aerosol variants.
- Collapse resistant with double shell construction made to withstand hot and humid conditions.
- Fringe seal avoids fluffy open layer around the edges.
- Natural rubber headband for more durability and comfortable fit.
- Contour design to ensure the compatibility of glasses/ goggles to reduce fogging.
- Moulded shape nose-piece ensure custom fit and increase the worker comfort and acceptance.
- Comply to EN 149
- 20 pcs/box 20 boxes/carton



CE
EN149

F313

CE
EN149



F323

Particulate Respirator F323

- FFP2 rating offering protection from solid and liquid aerosol variants.
- Collapse resistant with double shell construction made to withstand hot and humid conditions.
- Polyethylene (PE) outer layer provides smooth lining and avoids loose fibers.
- Fringe seal avoids fluffy open layer around the edges.
- Natural rubber headband for more durability and comfortable fit.
- Contour design to ensure the compatibility of glasses/ goggles to reduce fogging.
- Moulded shape nose-piece ensures custom fit and increase the worker comfort and acceptance.
- Comply to EN 149
- 20 pcs/box 20 boxes/carton



CE
EN149

F323V

Valve Particulate Respirator F323V

- With exhalation valve to reduces hot air build up and easier to breath in hot & humid environments.
- FFP2 rating offering protection from solid and liquid aerosol variants.
- Collapse resistant with double shell construction made to withstand hot and humid conditions.
- Polyethylene (PE) outer layer provides smooth lining and avoids loose fibers.
- Fringe seal avoids fluffy open layer around the edges.
- Natural rubber headband for more durability and comfortable fit.
- Contour design to ensure the compatibility of glasses/goggles to reduce fogging.
- Moulded shape nose-piece ensures custom fit and increase the worker comfort and acceptance.
- Comply to EN 149
- 10 pcs/box 20 boxes/carton

Valve Particulate Respirator F333V

- With exhalation valve to reduces hot air build up and easier to breath in hot & humid environments.
- FFP3 rating offering protection from fine dust, fibers, viruses and aqueous mist.
- Collapse resistant with double shell construction made to withstand hot and humid conditions.
- Polypropylene (PP) outer layer provides smooth lining and avoids loose fibers.
- Fringe seal avoids fluffy open layer around the edges.
- 4-point suspension with deluxe integral elastic adjustment for superior comfort.
- Contour design to ensure the compatibility of glasses/goggles to reduce fogging.
- Full Facial close-cell foam and adjustable nose-piece ensure custom shape and increase the worker comfort and acceptance.
- Comply to EN 149
- 10 pcs/box 20 boxes/carton



F333V

CE
EN149



Particulate Respirator HY8810/N95

- Low breathing resistance for increased wearer comfort. Fringe seal avoids open layer around the edges.
- With collapse resistant double shell construction made to withstand hot & humid conditions.
- Latex-free synthetic rubber head straps, adjustable nose clip and soft foam nose-piece for comfortable custom fit.
- Conforms to American NIOSH 42 CFR Part 84 standard as N95 class, with 95% filtration effective against particulate aerosols free of oils.
- NIOSH Approval number TC-84A-4229
- 20 pair/box 12 boxes/carton

HY8810/N95



Horizontal Flat-Fold Particulate Respirator HY8510/N95

- Low breathing resistance for increased wearer comfort. Soft edges fit different facial shapes with minimum leakage.
- Foldable design, seal edge avoids open layers & eliminates the possibility of irritation.
- Latex-free synthetic rubber head straps, adjustable nose clip and soft foam nose-piece for comfortable custom fit.
- Polypropylene (PP) outer/inner layer provides smooth lining and comfortable feel.
- Conforms to American NIOSH 42 CFR Part 84 standard as N95 class, with 95% filtration effective against particulate aerosols free of oils.
- NIOSH Approval number TC-84A-4276
- 20 pair/box 12 boxes/carton

HY8510/N95



PC821

ProMesh Respirator P2 PC821

- Flexible mesh which ensure optimum shape retention for a perfect, airtight fit during long period of wear.
- P2 rating protects against mechanically and thermally generated particles.
- Moulded nose piece for close fit.
- QuickLock strap for easy fit and release.
- Resealable polybag ensuring mask remain hygienically stored.
- 12 pcs/box 20 boxes/carton

ProMesh Respirator P2 with valve PC822

- Flexible mesh which ensure optimum shape retention for a perfect, airtight fit during long period of wear.
- P2 rating protects against mechanically and thermally generated particles.
- Moulded nose piece for close fit.
- QuickLock strap for easy fit and release.
- Exhalation "PROVALVE" for extra airflow.
- Resealable polybag ensuring mask remain hygienically stored.
- 12 pcs/box 20 boxes/carton

PC822



RESPIRATOR PROTECTION

PROGUARD SAFETY PRODUCTS CATALOGUE



GM306Y

GM305Y

Half Mask Respirator GM305Y/306Y

- Economic single or double cartridge half mask with soft durable facepiece.
- With adjustable elastic strap for comfortable seal.
- Deep chin cup for more roomy, comfortable inhaling & exhaling.
- 1 pair/box 50 pairs/carton



RC-202

RC-203

RC-201

Replacement Dust Cartridge RC-201

- Replacement cartridge suitable for protection against nuisance mist, large & non-toxic dust & pollen.
- 6pcs/box 60boxes/carton

Replacement Chemical Cartridge RC-202

- Replacement cartridge suitable for protection against organic vapors, mist & fumes of low toxicity.
- 6pcs/box 60boxes/carton

Replacement Chemical Cartridge RC-203

- Replacement cartridge suitable for protection against organic vapors, mist, fumes of low toxicity & paint spray.
- All above cartridges can be use with GM305Y & GM306Y half mask respirator.
- 6pcs/box 60boxes/carton



8210

3M Particulate Respirator 8210

- Extremely lightweight.
- Provides respiratory protection against fine particulates.
- Excellent fit over wide range of size with adjustable nose clip which helps to providing custom fit and secure seal.
- Comply to JKKP DR65/99
- 20 pcs/box 8 boxes/carton



3200

3M Single Cartridge Half Facepiece Respirators 3000 Series

3200

- These single cartridge half facepiece respirators are lightweight & cradle head harness increase comfort.
- Ideal for spray painting, chemical spraying, coating fumigation, degreasing, cleaning & etc.
- Comply to JKKP MR46/98
- 12 pair/box 20 boxes/carton



6200

3M Half Facepiece Respirators 6200

- Lightweight & low-maintenance design for maximum comfort.
- These half facepiece respirators offers quality breathing protection at an exceptional price.
- Comply to JKKP MR52/99
- 12 pair/box 20 boxes/carton



3M Replacement Cartridges 6000 Series

- To be use with 3M Facepieces 6000 Series with bayonet cartridge holders against a variety of gases, vapors and particulate hazards according to NIOSH approvals.

3M Organic Vapor Cartridge 6001

- NIOSH approved cartridge against certain organic vapors.
- 2pcs/pkt 30 pkt/carton

3M Acid Gas Cartridge 6002

- NIOSH approved cartridge against certain acid gases.
- 2pcs/pkt 30 pkt/carton

3M Organic Vapor/Acid Gas Cartridge 6003

- NIOSH approved cartridge against certain organic vapors or acid gases.
- 2pcs/pkt 30 pkt/carton

3M Ammonia Methylamine Cartridge 6004

- NIOSH approved cartridge against ammonia and methylamine.
- 2pcs/pkt 30 pkt/carton

3M™ Formaldehyde/Organic Vapor Cartridge 6005

- NIOSH approved cartridge against formaldehyde and certain organic vapors.
- 2pcs/pkt 30 pkt/carton

3M Multi Gas/Vapor Cartridge 6006

- NIOSH approved cartridge against certain organic vapors, acid gases, ammonia, methylamine or formaldehyde.
- 2pcs/pkt 30 pkt/carton

3M Particulate Filter 5N11, N95

- NIOSH approved filters for environments containing certain non-oil based particles. To be use with 3M Cartridges 6000 Series and 3M Filter Retainers 501.
- 10 pcs/box 10 boxes/carton

3M Filter Retainer 501

- Used to hold 3M Particulate Filters 5N11 in place on top of Respirators 6000 Series and Cartridges 6000 Series.
- 20 pcs/box 10 boxes/carton



CE
EN136

IN-3000



CE
EN136

INDIN-T



CE
EN136

C809MG

INAIR Full Face Mask IN-3000

- Full face mask with a wide field of vision.
- EPDM rubber face piece.
- One size fits all faces.
- Complies with EN136 (Class2). For use dust, gas and combines filters with a threaded connector conforms to EN148/1
- 1 unit/box

INAIR Wide View Full Face Mask INDIN-T

- Extra wide view full face mask.
- Neoprene rubber face piece.
- One size fits all faces.
- Complies with EN136 (Class2) with a threaded connector conforms to EN148/1
- 1 unit/box

Full Face Mask C809MG

- Full face mask with a wide field of vision.
- EPDM rubber face piece.
- One size fits all faces.
- Complies with EN136 (Class2). For use dust, gas and combines filters with a threaded connector conforms to EN148/1
- 1 unit/box

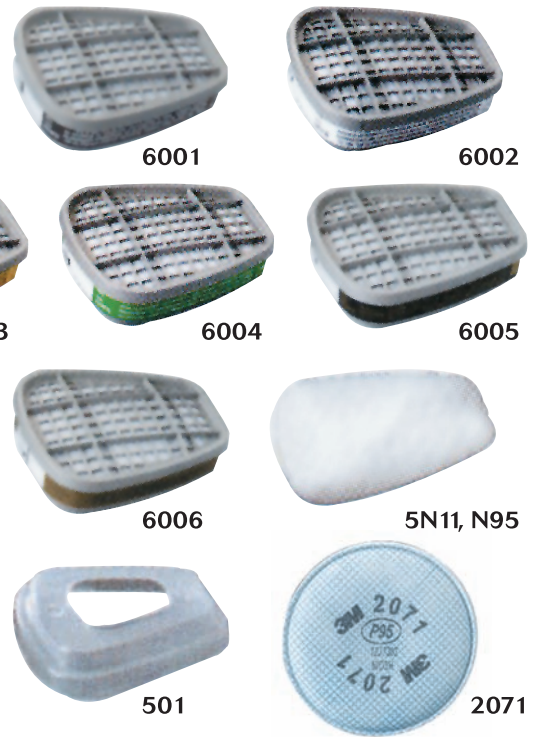

3M Particulate Filter 2071

- NIOSH approved filters for environments containing certain oil and non-oil based particles. To be use with 3M Respirators 6000 Series.
- 12 pair/box 20 boxes/carton



3011K-55

3M Organic Vapor Cartridge 3011K-55

- NIOSH approved cartridge against certain organic vapors. To be use with 3M Respirators 3000 Series.
- 1pc/pkt 10 pkt/box



Product	Color Code	Application	Packing
4341.0600	A2	Organic Gases & Vapours (Boiling point above 65°C)	1 pc
4341.0601	B2	B2 Inorganic Gases & Vapours	1 pc
4341.0603	K2	K2 Ammonia Gases	1 pc
4341.0604	AX	AX Organic Gases & Vapours (Boiling point below 65°C)	1 pc
4341.0619	A2 B2	A2B2 Organic / Inorganic Gases & Vapours	1 pc
4341.0620	A2 P2	A2P2 Organic Vapors with P2 Filters	1 pc
4341.0638	A2 B2 E2 K2	A2B2E2K2 Combination	1 pc
4341.0590	P3	P3 HEPA Dust, Fumes, Mists & Radioactive	1 pc 10pcs/box

Sekur Replacement Filters

- The DIRIN 230 Series includes particulate, gas, vapors and combined filters.
- The filter case is made of light, impact resistant, synthetic resin.
- Conforms to EN141



INAIR Replacement Filters

The service time of respiratory filters depends on the conditions of use. For gas or combined filters that are used against gases, the end of a filter's service life usually can be detected by odour, taste or irritation during inhalation.

For particle filters or combined filters that are used against particles the end of service time can be detected by an increase in inhalation resistance.

With combined filters - depending on the predominant protective function - both criteria must be observed. Particle filters must only be used once against radioactive contaminants, spores, bacteria and virus.

- Cannister are made of ABS.
- Filters conforms to EN141 & EN143
- Thread conforms to EN148



Product	Application	Packing
INCA20-A2	A2 Organic Gases & Vapours (Boiling point above 65°C)	1 pc/box
INCA20-B2	B2 Inorganic Gases & Vapours	1 pc/box
INCA20-E2	E2 Sulphur Dioxide, Acid Gases & Vapours	1 pc/box
INCA20-K2	K2 Ammonia Gases	1 pc/box
INCA30-AX	AX Organic Gases & Vapours (Boiling point below 65°C)	1 pc/box
INCA30-A2P3	A2 Organic Gases & Vapours + P3 (Boiling point below 65°C)	1 pc/box
INCA30-AXP3	AX Organic Gases & Vapours + P3 (Boiling point below 65°C)	1 pc/box
INCA30-A2B2	A2B2 Organic / Inorganic Gases & Vapours	1 pc/box
INCA30-A2B2P3	A2B2 Organic / Inorganic Gases & Vapours + P3	1 pc/box
INCA30-ABEK	A2B2E2K2 Combination Filter	1 pc/box
INCA30-ABEKP3	A2B2E2K2 Combination Filter + P3	1 pc/box
INCA30-ABEKHgP3	Organic & Inorganic Gases & Vapours, Acid Gases, Ammonia Gases, Mercury + P3	1 pc/box
INPL20-P3	P3 HEPA Dust, Fumes, Mists & Radioactive	1 pc/box

Sekur – Diablo MM Self Contained Breathing Apparatus

4343.2294

- SFERA extra wide view (oval shape) EPDM rubber full face mask.
- 7L x 200 bar steel cylinder (35minutes duration)
- Fire retardant back plate with harness & padded shoulder for comfort.
- Self warning whistle – when the cylinder valve is opened until 55 bar.
- Fixed with A/P 400 – 1st Breath Activated Lung Demand Valve.
- Pressure gauge (Luminous)
- Conform to EN137
- 1 unit/case

Selecta Sekur Full Face Mask 4333.2030

- Full face mask with a wide field of vision.
- Neoprene rubber face piece.
- One size fits all faces.
- Complies with EN136 (Class2). For use dust, gas and combines filters with a threaded connector conforms to EN148/1
- 1 unit/box



4343.2294



4333.2030



INAIR Twin Filter Silicone Half Mask IN-2000S

- High quality silicone for hard wearing reliability.
- Lightweight and soft to the face.
- Designed to complement the facial contours for effective protective seal.
- Comfortable head cradle with 2 point adjustable suspension.
- Fits perfectly with twin filter cartridges.
- Complies with EN140
- 1pair/box

CE
EN140



INAIR Single Filter Silicone Half Mask IN-1000S

- High quality silicone for hard wearing reliability.
- Lightweight and soft to the face.
- Designed to complement the facial contours for effective protective seal.
- Comfortable head cradle with 2 point adjustable suspension.
- Fits perfectly with single filter cartridges.
- Complies with EN140
- 1pair/box

INAIR Replacement Filters

- To be use with INAIR's IN-1000 & IN-2000 Facepiece against variety of gases, vapours and particulate hazards.
- Complies with EN141
- For further information on substances, please refer to page for filter selection.



CE
EN140



Product	Application	Packing
IN-1-A1	Organic Gases & Vapours	1 pc
IN-1-B1	Inorganic Gases & Vapours	1 pc
IN-1-E1	Acid Gases & Vapours	1 pc
IN-2-K1	Ammonia Gases	1 pc
IN-2-A1P3	Organic Gases & Vapours + P3	1 pc
IN-2-B1P3	Inorganic Gases & Vapours + P3	1 pc
IN-2-E1P3	Acid Gases & Vapours + P3	1 pc
IN-2-K1P3	Ammonia Gases + P3	1 pc
IN-2-A1B1	Organic & Inorganic Gases & Vapours	1 pc
IN-2-A1B1E1K1	Organic & Inorganic Gases & Vapours, Sulphur Dioxide, Ammonia Gases	1 pc
IN-2-A1B1E1K1P3	Organic & Inorganic Gases & Vapours, Sulphur Dioxide, Ammonia Gases + P3	1 pc



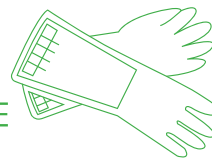

RNF-15



RNF-18

Super Nitrile Glove RNF-15

Length: 33cm (13") Thickness: 0.4mm + 0.03mm (15-16mils)
Qty/polybag: 1 pair Qty/carton: 144pairs

Super Nitrile Glove RNF-18

Length: 33cm (13") Thickness: 0.46mm + 0.03mm (17-19mils)
Qty/polybag: 1 pair Qty/carton: 144pairs

Super Nitrile Glove RNU-22

Length: 45cm (18") Thickness: 0.6mm + 0.03mm (22mils)
Qty/polybag: 1 pair Qty/carton: 36pairs



RNU-22

- Made from high quality nitrile rubber for long working life and heavy duty work.
- Excellent resistant to variety of chemical products and good against abrasion & punctures.
- Ergonomically & anatomical designed ensures user ease of movement and greater comfort.
- Size: 8, 9 & 10

Application: Chemical processing, oil refining, battery manufacturing, plant maintenance, pesticides handling, food processing & environmental waste clean up.



NIT-15

Economic Nitrile Glove NIT-15

- Made from nitrile rubber.
- Economical with resistant to variety of chemical products and good against abrasion & punctures.
- Ergonomically & anatomical designed ensures user ease of movement and greater comfort.
- Qty/polybag: 1 pair Qty/box: 144pairs

Application: Chemical processing, oil refining, battery manufacturing, plant maintenance, pesticides handling & environmental waste clean up.

Neoprene Glove NEO-400

Length: 33cm (13") Thickness: 0.72mm + 0.03mm (28-29mils)

- Made from superior neoprene rubber for excellent protection during long hours of continuous work and can be use under very difficult climatic conditions.
- Size: 8, 9 & 10
- 1 pair/polybag 100pairs/carton

Application: Petrochemical, automotive assembly, electronics, refinery, janitorial, handling oil, caustics, alcohols, acids and solvent.



NEO-400

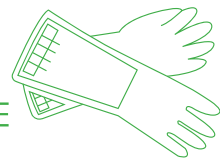

Black Knight Rubber Glove BK39-18

Length: 45cm (18") Thickness: 1.0mm + 0.03mm (39-40mils)

- Made from superior natural rubber with chemical resistant properties.
- Satin unlined interior for user comfort.
- Sanitised for anti-bacterial protection.
- Size: 8, 9 & 10
- 1 pair/polybag 36pairs/carton

Application: Mining, janitorial, metal-plating, chemical works and shot & sand blasting.



BK39-18

Heveaprene Glove HP-300

Length: 33cm (13") Thickness: 0.72mm + 0.03mm (28-29mils)

- Made from natural rubber coated with neoprene for excellent protection and economical.
- Multi purpose usage.
- Size: 8, 9 & 10
- 1 pair/polybag 100pairs/carton

Application: Automotive assembly, aviation industry, maintenance work, chemical work, food processing pesticide manufacturing, battery manufacturing & nuclear industry.



HP-300

Max Grip Glove DGNRC1

Length: 23-26cm (9" - 10") Thickness: 0.72mm + 0.03mm (28-29mils)

- Made from soft and sensitive unique rubber coating for excellent flexibility and dexterity.
- Crinkled finish provides excellent grip.
- Seamless knitted polycotton liner increase user comfort and reduce perspiration.
- Multi purpose usage.
- Size: 8, 9 & 10
- 1 pair/polybag 120pairs/carton

Application: Warehousing, refuse collection, construction, baggage handling & etc.



DGNRC1

PVC Coated Glove CG-650

Length: 27cm (11")

PVC Coated Glove CG-660

Length: 30cm (12")

- This industrial grade, fully coated vinyl dipped glove provides a superior chemical barrier when working with material such as acids, solvent, grease or oil.
- Thick PVC blended coating over a full cotton inner-lining for extra insulation and irritant free comfort.
- Sandy finish provides excellent wet grip performance and flexible durability.
- These PVC coated gloves can last up to 3 times as long as ordinary gloves.
- Hundred of usage.
- 10 pairs/pkt 10pkt/carton



CG-660

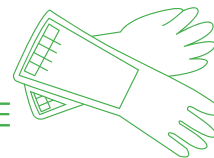

PU Coated Nylon Glove PU-700

Length: 23.5cm (9 1/2")

- Knitted with nylon fiber but the palm area is coated by polyurethane resin.
- Excellent resistance against water, slipping and wearing out. Has excellent ventilation and elasticity. Less fatigue of hands after long time of wear.
- Can use longer, since it is water-washable. Helpful to improve productivity of labors with excellent feeling of wearing.
- 1pair/polybag 100pairs/carton

Application: Widely being used for precision works, gardening, forestry, home, driving, sports and wiring, and for assemblies for electronic goods, TFT-LCD, automobile parts, and mobile phones, since it is soft and free from sweat by excellent ventilation.



PU-700

Elsec Insulation Glove Elsec 5/10/15/20

- These insulation gloves have been made to obtain high dielectric properties.
- Conform to EN60903
- Length: 33cm (13") & free size.
- 1pair/polybag 20pairs/carton

Description	Voltage
Elsec 5	5KV
Elsec 10	10KV
Elsec 15	15KV
Elsec 20	20KV



Elsec 5/10/15/20



DG-PE

Polyethylene Disposable Gloves DG-PE

- These disposable gloves are for general purpose & single use only.
- 1000 of uses and suitable for all food handling application but not suitable for medical use.
- Thickness: 1mil & free size.
- 100pcs/box 20boxes/carton

Disposable Latex Gloves DLG-PWF & DLG-PW

- These industrial latex gloves are for general purpose, quality glove designed to give good chemical protection from paint, dyes, thinners, solvent, bleaches, cleaning detergents, oil, grease and etc.
- Sensitivity, comfort and dexterity.
- Non-sterile & for single use only.
- Available with powder & powder free. Powder for easy on-off.
- Not suitable for medical use.
- Size: M, L & XL
- 100pcs/box 10boxes/carton



DLG-PWF & DLG-PW

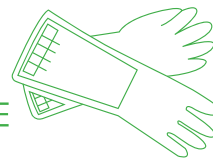

MDL/ MDLG-PF

Examination Latex Gloves MDL

- Made from high quality latex rubber.
- Sensitive touch for enhanced dexterity.
- Light powdered, close fitting.
- TGA-listed (ARTG 143968) for use in medical examination.
- Size: M, L & XL
- 100pcs/box 10boxes/carton

Examination Latex Gloves MDLG-PF

- Made from high quality latex rubber.
- Sensitive touch for enhanced dexterity.
- Powdered free for use where powder contamination may be an issue.
- TGA-listed (ARTG 143968) for use in medical examination.
- Fully textured for enhanced grip.
- Size: M, L & XL
- 100pcs/box 10boxes/carton

Application: Widely being used for medical examination, veterinary, pharmaceutical, food preparation & processing, painting, printing & etc.

Furniture Leather Gloves F2005AC

- These cow grain leather gloves are the most demanding glove, which offer general & basic protection.
- Full grain leather on all fingers, palm & strap cross the knuckle.
- Patched palm with cotton lined for comfort.
- Length: 23.5cm (9½") & free size.
- 12pairs/pkt 10pkt/carton



F2005AC

Semi Leather Gloves SLG-27BJ

- These cow split leather working gloves are the most popular glove, which offer general protection.
- Split leather on all fingers, palm & strap cross the knuckle.
- Patched palm with cotton lined for comfort.
- Length: 26cm (10½") & free size
- 12pairs/pkt 10pkt/carton



SLG-27BJ



PG20A



PG23A

Superior Rigger Chrome Leather Glove

PG20A/ PG23A

- Premier quality chrome split leather glove.
- Rubberise cuff with vein protection patch.
- Patched palm with quality cotton lined for extra comfort.
- Length: 27cm & free size.
- 12pair/pkt 10pkt/carton

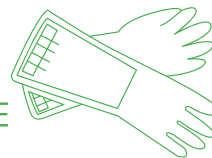

3143 CE



FLR-35



Full Leather Welding Gloves

FLG-35/ FLR-35

- These heavy duty leather welding gloves feature one-piece back construction.
- Made of top grade split leather, fully cotton lined and come with a high gauntlet cuff.
- Excellent quality & free size.
- 12pairs/pkt 5pkt/carton

3143 CE



FLG-35



S5181/13

Full Leather Welding Gloves

S5181/13

- These high quality split leather welding gloves offer general protection.
- Palm lined with reinforce stitching provides long lasting durability.
- Length: 33cm (13") & free size.
- 12pairs/pkt 10pkt/carton

Cotton Knitted Gloves

B-104/A-105

- Made of cotton yarn and its offer standard protection.
- General-purpose usage at a real value.
- Comfortable & easy to wear.
- 12pairs/pkt 20 pkt/bag



B-104/A-105

Polka-Dot Gloves

PDG-1033

- These 8.oz natural colour cotton/canvas gloves are come with a knitted wrist.
- Impregnated with small PVC dots on both palm and forefinger for a solid grip against any coated object.
- Comfortable & easy to wear.
- Length: 10½" (26cm) & free size.
- 12pairs/pkt 20 pkt/carton



PDG-1033

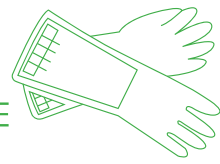

PG-118 GA



PG-119 YLW



AK/L027G

Argon Gloves PG-118 GA/ PG-119 YLW

- Full grain leathers which are comfortable to wear and offer maximum durability and exceptional comfort.
- Suitable for argon welding & others general application.
- Available in grey & yellow colours.
- Length: 27cm (11") & free size.
- 1pair/polybag 100pairs/carton

Argon Gloves AK/L027G

- Made of high quality full grain leather with binding tape.
- Extra comfort and offer high durability.
- Suitable for argon welding & others general application.
- Length: 25cm (10") & free size Colour: Grey
- 1pr/polybag 20doz/carton

Heat Resistant Gloves KYM/600/1

- 100% Aramid fabric with 5 finger glove.
- 2-ply offer effective protection & cut resistance.
- Provides high thermal insulation & extreme lightness.
- Resistance to constant temperature up to 250°C or short period of exposure to 400°C
- Length: 40cm (16") & free size.
- Meets: EN407 42XXXX & EN388
- Qty/box: 1pair



KYM/600/1



ALU/370/5F-PANOX



Heat Resistant Gloves ALU/370/5F-PANOX

- Aluminised 5-finger glove with combination of Panox & flame retardant wool fabric.
- Reinforcement at the palm provides excellent performance to heat resistance.
- Provides high thermal insulation & mechanical strength.
- Resistance to constant temperature up to 550°C or short period of exposure up to 850°C
- Length: 40cm (16") & free size.
- Meets: EN407 4444X4
- Qty/box: 1pair

FALL PROTECTION EQUIPMENTS

PROGUARD SAFETY PRODUCTS CATALOGUE

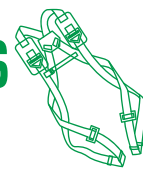

CE
EN361



SIRIM
CERTIFIED TO BS EN 361 : 2002
Certification No : PP071003



PG 141060

Full Body Harness PG 141060

- 1-pc dorsal attachment D-ring.
- Metal buckle type chest strap.
- Adjustable thigh strap.
- Shoulder and thigh straps differentiated by dual colour scheme.
- Available in Red/Yellow & High Visibility Orange/Black.



(Orange/Black)
PG 141060

- Ideally positioned sit strap for extended comfort.
- Comes with PG0190 MPB Multi Purpose Bag.
- Conform to BS EN361 & SIRIM certification no: PP071003

Product Code: PG141060	Size: Universal	Weight: 820gms	Packing: 1set/box 10sets/carton
---------------------------	--------------------	-------------------	------------------------------------



PG 141061

Full Body Harness PG 141061

- 1-pc dorsal attachment D-ring.
- Metal buckle type chest strap.
- Adjustable shoulder & thigh strap.
- Shoulder and thigh straps differentiated by dual colour scheme.
- Available in Red/Yellow & High Visibility Orange/Black.



(Orange/Black)
PG 141061

- Ideally positioned sit strap for extended comfort.
- Comes with PG0190 MPB Multi Purpose Bag.
- Conform to BS EN361 & SIRIM certification no: PP071003

Product Code: PG141061	Size: Universal	Weight: 1100gms	Packing: 1set/box 10sets/carton
---------------------------	--------------------	--------------------	------------------------------------



PG 141062

Full Body Harness PG 141062

- 1-pc dorsal attachment D-ring.
- 2-pcs chest attachment D-rings
- Metal buckle type chest strap.
- Adjustable shoulder & thigh strap.
- Shoulder and thigh straps differentiated by dual colour scheme.



(Orange/Black)
PG 141062

- Available in Red/Yellow & High Visibility Orange/Black.
- Ideally positioned sit strap for extended comfort.
- Comes with PG0190 MPB Multi Purpose Bag.
- Conform to BS EN361 & SIRIM certification no: PP071003

Product Code: PG141062	Size: Universal	Weight: 1200gms	Packing: 1set/box 10sets/carton
---------------------------	--------------------	--------------------	------------------------------------

FALL PROTECTION EQUIPMENTS

PROGUARD SAFETY PRODUCTS CATALOGUE



PG 141063

Full Body Harness PG 141063

- 1-pc dorsal attachment D-ring.
- 2-pcs chest attachment webbing loops.
- Metal buckle type chest strap.
- Adjustable thigh strap.
- Shoulder and thigh straps differentiated by dual colour scheme.



(Orange/Black)
PG 141063

- Available in Red/Yellow & High Visibility Orange/Black.
- Ideally positioned sit strap for extended comfort.
- Comes with PGO190 MPB Multi Purpose Bag.
- Conform to BS EN361 & SIRIM certification no: PP071003

Product Code:	Size:	Weight:	Packing:
PG141063	Universal	890gms	1set/box 10sets/carton

CE
EN361



SIRIM
CERTIFIED TO BS EN 361 : 2002
Certification No : PP071003



PG 141060 CBU

Full Body Harness with Built-in Lanyard PG 141060 CBU

- 1-pc dorsal attachment D-ring.
- Metal buckle type chest strap.
- Adjustable thigh strap.
- Shoulder and thigh straps differentiated by dual colour scheme.
- Available in Red/Yellow & High Visibility Orange/Black.



(Orange/Black)
PG 141060 CBU

- Ideally positioned sit strap for extended comfort.
- Built-in with 2.0meter polyamide lanyard with 1-pc press snap hook.
- Comes with PGO190 MPB Multi Purpose Bag.
- Conform to BS EN361, EN354 & SIRIM certification no: PP071003, PP71005

Product Code:	Size:	Weight:	Packing:
PG141060CBU	Universal	1300gms	1set/box 10sets/carton

CE
EN361
EN354



SIRIM
CERTIFIED TO BS EN 361 : 2002
Certification No : PP071003
CERTIFIED TO BS EN 354 : 2000
Certification No : PP071005



S718

Telecom Full Body Harness S718

- 1-pc dorsal attachment D-ring.
- 1-pc front attachment D-ring.
- 1-pc center waist attachment D-ring for sit support.
- 2-pcs side D-rings.
- Abrasion proof Ergopad backrest.



(Orange/Black)
S718

- Adjustable thigh, waist & shoulder straps.
- Available in Blue/Black & High Visibility Orange/Black.
- Comes with PGO190 MPB Multi Purpose Bag.
- Conform to BS EN361, EN358, EN813 & SIRIM certification no: PP071003, PP71006

Product Code:	Size:	Weight:	Packing:
S718	Universal	1980gms	1set/box 10sets/carton

CE
EN361
EN358
EN813



SIRIM
CERTIFIED TO BS EN 361 : 2002
Certification No : PP071003
CERTIFIED TO BS EN 358 : 2000
Certification No : PP071006

FALL PROTECTION EQUIPMENTS

PROGUARD SAFETY PRODUCTS CATALOGUE

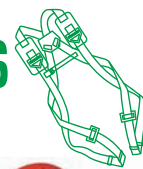

PG 141060 EB

Full Body Harness with Eco Belt PG 141060 EB

- 1-pc dorsal attachment D-ring.
- Metal buckle type chest strap.
- Adjustable thigh strap.
- Adjustable waist support belt.
- 2-pcs lateral positioning D-rings.



(Orange/Black)
PG 141060 EB

- Shoulder and thigh straps differentiated by dual colour scheme.
- Available in Orange/Blue & High Visibility Orange/Black.
- Ideally positioned sit strap for extended comfort.
- Comes with PG0190 MPB Multi Purpose Bag.
- Conform to BS EN361, EN358 & SIRIM certification no: PP071003, PP71006

Product Code:	Size:	Weight:	Packing:
PG141060-EB	Universal	1600gms	1set/box 10sets/carton

CE
EN361
EN358



SIRIM
CERTIFIED TO BS EN 361 : 2002
Certification No : PP071003
CERTIFIED TO BS EN 358 : 2000
Certification No : PP071006



CE
EN361



SIRIM
CERTIFIED TO BS EN 361 : 2002
Certification No : PP071003

BH7886

Economic Full Body Harness BH7886

- 1-pc dorsal attachment D-ring with back-pad.
- Metal buckle type chest strap.
- Adjustable thigh strap.
- Available in Blue colour with black strips.
- Ideally positioned sit strap for extended comfort.
- Comes with PG0180 MPB Multi Purpose Bag.
- Conform to BS EN361 & SIRIM certification no: PP071003

Product Code:	Size:	Weight:	Packing:
BH7886	Universal	820gms	1set/box 10sets/carton



CE
EN361
EN354



SIRIM
CERTIFIED TO BS EN 361 : 2002
Certification No : PP071003
CERTIFIED TO BS EN 354 : 2002
Certification No : PP071005

BH7886 CBU

Full Body Harness with Built-in Lanyard BH7886 CBU

- 1-pc dorsal attachment D-ring with back-pad.
- Metal buckle type chest strap.
- Adjustable thigh strap.
- Available in Blue colour with black strips.
- Ideally positioned sit strap for extended comfort.
- Built-in with 2.0meter polyamide lanyard with 1-pc press snap hook.
- Comes with PG0180 MPB Multi Purpose Bag.
- Conform to BS EN361, BS EN354 & SIRIM certification no: PP071003, PP71005

Product Code:	Size:	Weight:	Packing:
BH7886CBU	Universal	1300gms	1set/box 10sets/carton



CE
EN361



SIRIM
CERTIFIED TO BS EN 361 : 2002
Certification No : PP071003

S710

Basic Full Body Harness S710

- 1-pc dorsal attachment D-ring.
- Metal buckle type chest strap.
- Adjustable thigh strap.
- Shoulder and thigh straps differentiated by dual colour scheme.
- Available in Yellow/Black colour.
- Ideally positioned sit strap for extended comfort.
- Comes with PG0190 MPB Multi Purpose Bag.
- Conform to BS EN361 & SIRIM certification no: PP071003

Product Code:	Size:	Weight:	Packing:
S710	Universal	820gms	1set/box 10sets/carton

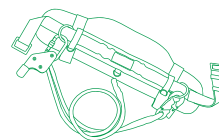

PG 141059-S-PRO

CE
EN358



SIRIM
CERTIFIED TO BS EN 358 : 2000
Certification No. : PP071006



(Orange/Black)
PG 141059-S-PRO

Work Positioning Belt PG 141059-S-PRO

- Abrasion proof & narrow back comfort pad.
- 2-pcs lateral positioning D-rings.
- Tools holder loops and ring for tool bags.
- Available in Red/Yellow & High Visibility Orange/Black.
- Built-in with S234 Work Positioning Lanyard.
- Conform to BS EN358 & SIRIM certification no: PP071006

Product Code:	Size:	Weight:	Packing:
PG141059-S-PRO	Universal	1400gms	1set/box



PG 141059-S-PAX

CE
EN358
EN354



SIRIM
CERTIFIED TO BS EN 358 : 2000
Certification No. : PP071006
CERTIFIED TO BS EN 354 : 2002
Certification No. : PP071005



PG 141059-D-PAX

CE
EN358
EN354



SIRIM
CERTIFIED TO BS EN 358 : 2000
Certification No. : PP071006
CERTIFIED TO BS EN 354 : 2002
Certification No. : PP071005



(Orange/Black)
PG 141059-S-PAX

(Orange/Black)
PG 141059-D-PAX



Work Positioning Belt PG 141059-S-PAX

- Abrasion proof & narrow back comfort pad.
- 2-pcs lateral positioning D-rings.
- Tools holder loops and ring for tool bags.
- Available in Red/Yellow & High Visibility Orange/Black.
- Built-in with 1-pc carabiner with 2 meter polyamide lanyard & 1-pc press snap hook.
- Conform to BS EN358 & SIRIM certification no: PP071006 for Work Positioning Belt;
BS EN354 & SIRIM certification no: PP071005 for Lanyard.

Product Code:	Size:	Weight:	Packing:
PG141059-S-PAX	Universal	1100gms	1set/box

Work Positioning Belt PG 141059-D-PAX

- Abrasion proof & wide back comfort pad.
- 2-pcs lateral positioning D-rings.
- Tools holder loops and ring for tool bags.
- Available in Red/Yellow & High Visibility Orange/Black.
- Built-in with 1-pc carabiner with 2 meter polyamide lanyard & 1-pc press snap hook.
- Conform to BS EN358 & SIRIM certification no: PP071006 for Work Positioning Belt;
BS EN354 & SIRIM certification no: PP071005 for Lanyard.

Product Code:	Size:	Weight:	Packing:
PG 141059-D-PAX	Universal	1300gms	1set/box

FALL PROTECTION EQUIPMENTS

PROGUARD SAFETY PRODUCTS CATALOGUE

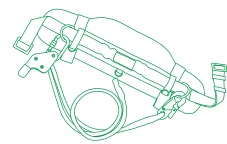

PG141059-D-PRO

CE
EN358



SIRIM
CERTIFIED TO BS EN 358 : 2000
Certification No : PP071006

(Orange/Black)
PG141059-D-PRO



(Orange/Black)
PG141059-S-PLUS



CE
EN358



SIRIM
CERTIFIED TO BS EN 358 : 2000
Certification No : PP071006

PG141059-S-PLUS



Work Positioning Belt PG141059-D-PRO

- Abrasion proof & wide back comfort pad.
- 2-pcs lateral positioning D-rings.
- Tools holder loops and ring for tool bags.
- Available in Red/Yellow & High Visibility Orange/Black.
- Built-in with S234 Work Positioning Lanyard.
- Conform to BS EN358 & SIRIM certification no: PP071006

Product Code:	Size:	Weight:	Packing:
PG141059-D-PRO	Universal	1500gms	1set/box

Work Positioning Belt PG141059-S-PLUS

- Abrasion proof & narrow back comfort pad.
- 2-pcs lateral positioning D-rings.
- Tools holder loops and ring for tool bags.
- Available in Red/Yellow & High Visibility Orange/Black.
- Built-in with Jynx 3 Work Positioning Lanyard.
- Conform to BS EN358 & SIRIM certification no: PP071006

Product Code:	Size:	Weight:	Packing:
PG141059-S-PLUS	Universal	1100gms	1set/box



PG141059-D-PLUS

CE
EN358



SIRIM
CERTIFIED TO BS EN 358 : 2000
Certification No : PP071006

(Orange/Black)
PG141059-D-PLUS



CE
EN358
EN813



SIRIM
CERTIFIED TO BS EN 358 : 2000
Certification No : PP071006



S181

Work Positioning Belt PG141059-D-PLUS

- Abrasion proof & wide back comfort pad.
- 2-pcs lateral positioning D-rings.
- Tools holder loops and ring for tool bags.
- Available in Red/Yellow & High Visibility Orange/Black.
- Built-in with Jynx 3 Work Positioning Lanyard.
- Conform to BS EN358 & SIRIM certification no: PP071006

Product Code:	Size:	Weight:	Packing:
PG141059-D-PLUS	Universal	1200gms	1set/box

Work Positioning Seat Harness S181

- Abrasion proof & wide back comfort pad.
- 2-pcs lateral positioning D-rings with 1-pc front waist work positioning D-ring.
- Curved D-rings to facilitate connection to hooks.
- Comes with PG0190 MPB Multi Purpose Bag.
- Conform to BS EN358, EN813 & SIRIM certification no: PP071006

Product Code:	Size:	Weight:	Packing:
S181	Universal	1200gms	1set/box 10sets/carton

FALL PROTECTION EQUIPMENTS

PROGUARD SAFETY PRODUCTS CATALOGUE

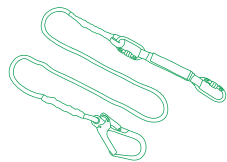

PG141051

Double D-ring Safety Belt PG141051

- 50mm width webbing with standard tool bag.
- 2-pcs lateral positioning D-rings.
- Built-in with 12mm x 1.6meter polyamide lanyard with 1-pc press snap hook.

Product Code:	Size:	Weight:	Packing:
PG141051	Universal	790gms	1set/box 20sets/carton



PG141054

Single D-ring Safety Belt PG141054

- 50mm width webbing with standard tool bag.
- 1-pc lateral positioning D-rings.
- Built-in with 12mm x 1.6meter polyamide lanyard with 1-pc press snap hook.

Product Code:	Size:	Weight:	Packing:
PG141054	Universal	720gms	1set/box 20sets/carton

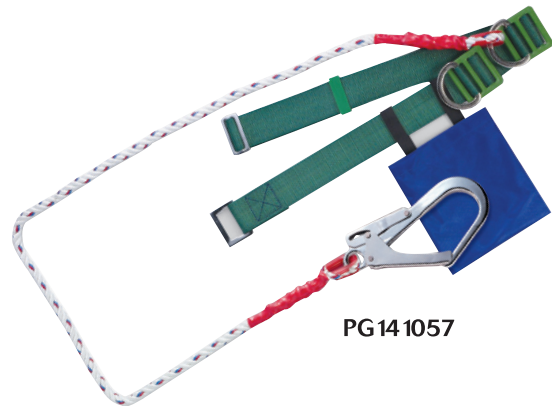

PG141057

Double D-ring Safety Belt PG141057

- 50mm width webbing with standard tool bag.
- 2-pcs lateral positioning D-rings.
- Built-in with 12mm x 1.6meter polyamide lanyard with 1-pc large opening hook.

Product Code:	Size:	Weight:	Packing:
PG141057	Universal	990gms	1set/box 10sets/carton



ESB1

Economic Safety Belt ESB1

- 50mm width webbing with standard tool bag.
- 1-pc lateral positioning D-rings.
- Built-in with 10mm x 1.6meter polyamide lanyard with 1-pc press snap hook.

Product Code:	Size:	Weight:	Packing:
ESB1	Universal	600gms	1set/box 20sets/carton



PG300/S740

Energy Absorber PG300/S740

- Standard version which made of 44mm width webbing.
- Can be fitted to spring, webbing or polyamide lanyard for shock absorbing purposes should a fall occur.
- Impact force will be under 6kN.
- Available in High Visibility Orange or Red Colour.
- Conform to BS EN355 & SIRIM certification no: PP071004

Mini Energy Absorber S740-M1

- Budget & mini version which made of 25mm width webbing.
- Can be fitted to spring, webbing or polyamide lanyard for shock absorbing purposes should a fall occur.
- Impact force will be under 6kN.
- Available in Natural White.
- Conform to BS EN355 & SIRIM certification no: PP071004

S740-M1



Product Code:	Size:	Packing:
PG300/S740	Standard	1pc
S740-M1	Mini	1pc



FALL PROTECTION EQUIPMENTS

PROGUARD SAFETY PRODUCTS CATALOGUE

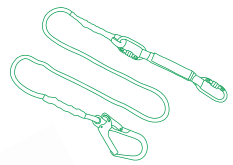

Spring Lanyard FL-1SH

Very good flexibilities. When released, it stays close to the user's body, reducing the possibility of trips and snags. Retracted length is 1.0m and extended total length to 1.6m.

- These single flexible lanyard built-in with 1-pc snap hook.
- Conform to BS EN354 & SIRIM certification no: PP071005



FL-1SH



FL-1LH



EN354



SIRIM
CERTIFIED TO BS EN 354 : 2002
Certification No : PP071005

Spring Lanyard FL-1LH

- These single flexible lanyard built-in with 1-pc large opening hook.
- Conform to BS EN354 & SIRIM certification no: PP071005

Product Code:	Packing:
FL-1SH	1set/box 20sets/carton
FL-1LH	1set/box 20sets/carton



FL-TW2SH&C



FL-TW2LH&C



EN354



SIRIM
CERTIFIED TO BS EN 354 : 2002
Certification No : PP071005

Twin Spring Lanyard FL-TW2SH&C

Performance as per single flexible lanyard but these twin lanyards allow user to move constantly attached to an anchorage providing added safety features.

- Built in with 2pc FL-1SH spring lanyard with 1-pc carabiner.
- Conform to BS EN354 & SIRIM certification no: PP071005

Twin Spring Lanyard FL-TW2LH&C

- Built in with 2pc FL-1LH spring lanyard with 1-pc carabiner.
- Conform to BS EN354 & SIRIM certification no: PP071005

Product Code:	Packing:
FL-TW2SH&C	1set/box 10sets/carton
FL-TW2LH&C	1set/box 10sets/carton

FL-141065-SH



EN354
EN355



SIRIM
CERTIFIED TO BS EN 354 : 2002
Certification No : PP071005
CERTIFIED TO BS EN 355 : 2002
Certification No : PP071004

Spring Lanyard with Energy Absorber FL-141065-SH

Combination spring lanyard with energy absorber has good absorbing properties should a fall occur. When released, it stays close to the user's body, reducing the possibility of trips and snags. Retracted length is 1.4m and extended total length to 2.0m. Static strength more than 22kN and impact force will be under 6kN.

- Built in with 1 pc FL-1SH spring lanyard with 2-pcs carabiner & energy absorber.
- Conform to BS EN354 & SIRIM certification no: PP071005 for Lanyard; BS EN355 & SIRIM certification no: PP071004 for Energy Absorber.

Spring Lanyard with Energy Absorber FL-141069-LH

- Built in with 1pc FL-1LH spring lanyard with 2-pcs carabiner & energy absorber.
- Conform to BS EN354 & SIRIM certification no: PP071005 for Lanyard; BS EN355 & SIRIM certification no: PP071004 for Energy Absorber.

Product Code:	Packing:
FL-141065-SH	1set/box 10sets/carton
FL-141069-LH	1set/box 10sets/carton



FL-141069-LH

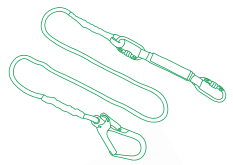

Twin Spring Lanyard with Energy Absorber FL-141067-PH

Performance as per single flexible lanyard but these twin lanyards allow user to move constantly attached to an anchorage providing added safety features.

- Built in with 2pcs FL-1SH spring lanyard with 2-pcs carabiner & energy absorber.
- Conform to BS EN354 & SIRIM certification no: PP071005 for Lanyard;
BS EN355 & SIRIM certification no: PP071004 for Energy Absorber.



FL-141067-PH



SIRIM
CERTIFIED TO BS EN 354 : 2002
Certification No : PP071005
CERTIFIED TO BS EN 355 : 2002
Certification No : PP071004

Twin Spring Lanyard with Energy Absorber FL-141068-LOH

- Built in with 2pc FL-1LH spring lanyard with 2-pcs carabiner & energy absorber.
- Conform to BS EN354 & SIRIM certification no: PP071005 for Lanyard;
BS EN355 & SIRIM certification no: PP071004 for Energy Absorber.



FL-141068-LOH

Product Code:	Packing:
FL-141067-PH	1set/box 10sets/carton
FL-141068-LOH	1set/box 10sets/carton



JYNX3

Webbing Work Positioning Lanyard JYNX3

Budget version positioning lanyard for work positioning belt.

- Folded webbing lanyard with 2-pcs carabiner & adjustable figure-8.
- Conform to BS EN358 & SIRIM certification no: PP071006



S234



SIRIM
CERTIFIED TO BS EN 358 : 2000
Certification No : PP071006

Work Positioning Lanyard S234

A premium type positioning lanyard with a user-friendly one hand operated length adjuster.

- Polyamide lanyard with 1-pc carabiner, 1-pc snap hook & 1-pc rope adjustable.
- Conform to BS EN358 & SIRIM certification no: PP071006

Product Code:	Packing:
JYNX3	1set/box 20sets/carton
S234	1set/box 10sets/carton

Webbing Lanyard WL-1SH

Manufacturer from highly resistant polyester webbing, this is a general purpose fall arrest lanyard that suits almost any environments.

- Folded 1.6meter webbing lanyard with 1-pc press snap hook.
- Conform to BS EN354 & SIRIM certification no: PP071005



WL-1SH



SIRIM
CERTIFIED TO BS EN 354 : 2002
Certification No : PP071005

Webbing Lanyard WL-1LH

- Folded 1.6meter webbing lanyard with 1-pc large opening hook.
- Conform to BS EN354 & SIRIM certification no: PP071005

Product Code:	Packing:
WL-1SH	1set/box 20sets/carton
WL-1-LH	1set/box 10sets/carton



WL-1LH

FALL PROTECTION EQUIPMENTS

PROGUARD SAFETY PRODUCTS CATALOGUE

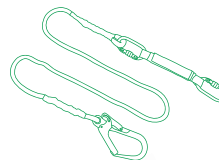

Webbing Lanyard with Energy Absorber WL-141065-SH

Single webbing lanyard integrated with an energy absorber provides good absorbing properties should a fall occur. Static strength more than 22kN and impact force will be under 6kN.

- Folded 1.6meter webbing lanyard with 1-pc press snap hook with 2-pcs carabiner & energy absorber.
- Conform to BS EN354 & SIRIM certification no: PP071005 for Lanyard; BS EN355 & SIRIM certification no: PP071004 for Energy Absorber.

WL-141065-SH



SIRIM
CERTIFIED TO BS EN 354 : 2002
Certification No : PP071005
CERTIFIED TO BS EN 355 : 2002
Certification No : PP071004



WL-141069-LH

Webbing Lanyard with Energy Absorber WL-141069-LH

- Folded 1.6meter webbing lanyard with 1-pc large opening hook with 2-pcs carabiner & energy absorber.
- Conform to BS EN354 & SIRIM certification no: PP071005 for Lanyard; BS EN355 & SIRIM certification no: PP071004 for Energy Absorber.

Product Code:	Packing:
WL-141065-SH	1set/box 10sets/carton
WL-141069-LH	1set/box 10sets/carton

Twin Webbing Lanyard with Energy Absorber

WL-141067-PH

Twin webbing lanyard integrated with an energy absorber provides good absorbing properties should a fall occur. Static strength more than 22kN and impact force will be under 6kN.

- Built-in with 2pcs WL-1SH webbing lanyard with 2-pcs carabiner & energy absorber.
- Conform to BS EN354 & SIRIM certification no: PP071005 for Lanyard; BS EN355 & SIRIM certification no: PP071004 for Energy Absorber.

Twin Webbing Lanyard with Energy Absorber

WL-141068-LOH

- Built-in with 2pcs WL-1LH webbing lanyard with 2-pcs carabiner & energy absorber.
- Conform to BS EN354 & SIRIM certification no: PP071005 for Lanyard; BS EN355 & SIRIM certification no: PP071004 for Energy Absorber.

Product Code:	Packing:
WL-141067-PH	1set/box 10sets/carton
WL-141068-LOH	1set/box 10sets/carton

Polyamide Lanyard with Press Snap Hook & Large Opening Hook

2.0M-CSLH

Made of polyamide 3 strand ropes with indicator orange & black running lines. Replace it when the running lines fade which indicates that the lanyard life has worn out.

- Rope size is 12mm dia. x 2 meter polyamide lanyard built-in with 1-pc press snap hook & 1-pc large opening hook.
- Conform to BS EN354 & SIRIM certification no: PP071005

Product Code:	Length:	Packing:
2.0M-CSLH	2.0m	1set/box 24sets/carton

Polyamide Lanyard with Press Snap Hook

1.6M-SH/ 2.0M-SH

Made of polyamide 3 strand ropes with indicator orange & black running lines. Replace it when the running lines fade which indicates that the lanyard life has worn out.

- Rope size is 12mm dia. x 1.6meter or 2 meter polyamide lanyard built-in with 1-pc press snap hook.
- Conform to BS EN354 & SIRIM certification no: PP071005
- 1 set/ box 20sets/carton

Product Code:	Length:	Packing:
1.6M-SH	1.6m	1set/box 24sets/carton
2.0M-SH	2.0m	1set/box 24sets/carton



SIRIM
CERTIFIED TO BS EN 354 : 2002
Certification No : PP071005
CERTIFIED TO BS EN 355 : 2002
Certification No : PP071004



WL-141067-PH



SIRIM
CERTIFIED TO BS EN 354 : 2002
Certification No : PP071005
CERTIFIED TO BS EN 355 : 2002
Certification No : PP071004



WL-141068-LOH



SIRIM
CERTIFIED TO BS EN 354 : 2002
Certification No : PP071005



2.0M-CSLH



SIRIM
CERTIFIED TO BS EN 354 : 2002
Certification No : PP071005



1.6M-SH/ 2.0M-SH

FALL PROTECTION EQUIPMENTS

PROGUARD SAFETY PRODUCTS CATALOGUE

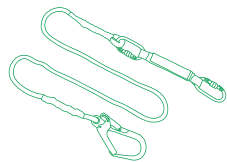

Polyamide Lanyard with Large opening Hook 1.6M-LH/ 2.0M-LH

- Rope size is 12mm dia. x 1.6meter or 2 meter polyamide lanyard built-in with 1-pc large opening hook.
- Conform to BS EN354 & SIRIM certification no: PP071005

Product Code:	Length:	Packing:
1.6M-LH	1.6m	1set/box 24sets/carton
2.0M-LH	2.0m	1set/box 24sets/carton



SIRIM
CERTIFIED TO BS EN 354 : 2002
Certification No : PP071005
CERTIFIED TO BS EN 355 : 2002
Certification No : PP071004



PG141065-SH



1.6M-LH/ 2.0M-LH



SIRIM
CERTIFIED TO BS EN 354 : 2002
Certification No : PP071005

Polyamide Lanyard with Energy Absorber PG141065-SH

Most basic polyamide lanyard integrated with an energy absorber provides good absorbing properties should a fall occur. Static strength more than 22kN and impact force will be under 6kN.

- Built-in with 1.6M-SH lanyard with 2-pcs carabiner & energy absorber.
- Conform to BS EN354 & SIRIM certification no: PP071005 for Lanyard; BS EN355 & SIRIM certification no: PP071004 for Energy Absorber.

Polyamide Lanyard with Energy Absorber PG141069-LH

- Built-in with 1.6M-LH lanyard with 2-pcs carabiner & energy absorber.
- Conform to BS EN354 & SIRIM certification no: PP071005 for Lanyard; BS EN355 & SIRIM certification no: PP071004 for Energy Absorber.

Product Code:	Packing:
PG141065-SH	1set/box 10sets/carton
PG141069-LH	1set/box 10sets/carton



SIRIM
CERTIFIED TO BS EN 354 : 2002
Certification No : PP071005
CERTIFIED TO BS EN 355 : 2002
Certification No : PP071004



PG141067-PH



PG141069-LH



SIRIM
CERTIFIED TO BS EN 354 : 2002
Certification No : PP071005
CERTIFIED TO BS EN 355 : 2002
Certification No : PP071004

Twin Polyamide Lanyard with Energy Absorber PG141067-PH

Twin polyamide lanyard integrated with an energy absorber provides good absorbing properties should a fall occur. Static strength more than 22kN and impact force will be under 6kN.

- Built-in with 2pc-1.6M-SH lanyard with 2-pcs carabiner & energy absorber.
- Conform to BS EN354 & SIRIM certification no: PP071005 for Lanyard; BS EN355 & SIRIM certification no: PP071004 for Energy Absorber.

Twin Polyamide Lanyard with Energy Absorber PG141068-LOH

- Built-in with 2-pcs 1.6M-LH lanyard with 2-pcs carabiner & energy absorber.
- Conform to BS EN354 & SIRIM certification no: PP071005 for Lanyard; BS EN355 & SIRIM certification no: PP071004 for Energy Absorber.

Product Code:	Packing:
PG141067-PH	1set/box 10sets/carton
PG141068-LOH	1set/box 10sets/carton



PG141068-LOH



SIRIM
CERTIFIED TO BS EN 354 : 2002
Certification No : PP071005
CERTIFIED TO BS EN 355 : 2002
Certification No : PP071004

FALL PROTECTION EQUIPMENTS

PROGUARD SAFETY PRODUCTS CATALOGUE

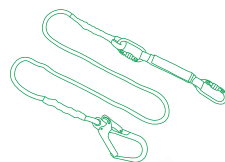

Economic Polyamide Lanyard with Press Snap Hook & Large Opening Hook EV280-CSLH

Made with economical polyamide 3 strand ropes with indicator red & blue running lines. Replace it when the running lines fade which indicates that the lanyard life has worn out.

- Rope size is 12mm dia. x 2.0 meter polyamide lanyard built-in with 1-pc press snap hook & 1-pc large opening hook.
- Conform to BS EN354 & SIRIM certification no: PP071005

Product Code:	Packing:
EV280-CSLH	1set/box 24sets/carton

Economic Polyamide Lanyard with 2pcs Large Opening Hook EV290-2LH

- Rope size is 12mm dia. x 2.0 meter polyamide lanyard built-in with 2-pcs large opening hook.
- Conform to BS EN354 & SIRIM certification no: PP071005

Product Code:	Packing:
EV290-2LH	1set/box 24sets/carton



EV280-CSLH

EV290-2LH

CE
EN354



CE
EN354



SIRIM
CERTIFIED TO BS EN 354 : 2002
Certification No : PP071005



EV200-SH (2.0M)

EV220-SH (1.6M)

Economic Polyamide Lanyard with Press Snap Hook EV200-SH/ EV220-SH

Made with economical polyamide 3 strand ropes with indicator red & blue running lines. Replace it when the running lines fade which indicates that the lanyard life has worn out.

- Rope size is 12mm dia. x 1.6meter or 2meter polyamide lanyard built-in with 1-pc press snap hook.
- Conform to BS EN354 & SIRIM certification no: PP071005

Product Code:	Length:	Packing:
EV200-SH	2.0m	1set/box 24sets/carton
EV220-SH	1.6m	1set/box 24sets/carton

EV210-LOH (2.0M)

EV230-LOH (1.6M)

CE
EN354



SIRIM
CERTIFIED TO BS EN 354 : 2002
Certification No : PP071005

Economic Polyamide Lanyard with Large Opening Hook EV210-LOH/ EV230-LOH

- Rope size is 12mm dia. x 1.6meter or 2meter polyamide lanyard built-in with 1-pc large opening hook.
- Conform to BS EN354 & SIRIM certification no: PP071005

Product Code:	Length:	Packing:
EV210-LOH	2.0m	1set/box 24sets/carton
EV230-LOH	1.6m	1set/box 24sets/carton



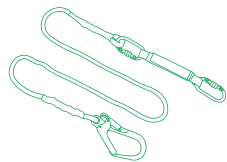

Polyamide Lanyard with Energy Absorber EV240-LOH

Economic polyamide lanyard integrated with a mini energy absorber provides good absorbing properties should a fall occur. Static strength more than 22kN and impact force will be under 6kN.

- Built-in with EV230-LOH lanyard with 2-pcs carabiner & mini energy absorber.
- Conform to BS EN354 & SIRIM certification no: PP071005 for Lanyard; BS EN355 & SIRIM certification no: PP071004 for Energy Absorber.



EV260-SH



EV240-LOH



SIRIM
CERTIFIED TO BS EN 354 : 2002
Certification No: PP071005
CERTIFIED TO BS EN 355 : 2002
Certification No: PP071004

Polyamide Lanyard with Energy Absorber EV260-SH

- Built-in with EV220-SH lanyard with 2-pcs carabiner & mini energy absorber.
- Conform to BS EN354 & SIRIM certification no: PP071005 for Lanyard; BS EN355 & SIRIM certification no: PP071004 for Energy Absorber.

Product Code:	Packing:
EV240-LOH	1set/box 10sets/carton
EV260-SH	1set/box 10sets/carton



EV250-LOH



SIRIM
CERTIFIED TO BS EN 354 : 2002
Certification No: PP071005
CERTIFIED TO BS EN 355 : 2002
Certification No: PP071004

Twin Polyamide Lanyard with Energy Absorber EV250-LOH

Made with economical twin polyamide lanyard integrated with an energy absorber provides good absorbing properties should a fall occur. Static strength more than 22kN and impact force will be under 6kN.

- Built-in with 2pc-EV230-LOH lanyard with 2-pcs carabiner & mini energy absorber.
- Conform to BS EN354 & SIRIM certification no: PP071005 for Lanyard; BS EN355 & SIRIM certification no: PP071004 for Energy Absorber.



EV270-SH

Twin Polyamide Lanyard with Energy Absorber EV270-SH

Made with economical twin polyamide lanyard integrated with an energy absorber provides good absorbing properties should a fall occur. Static strength more than 22kN and impact force will be under 6kN.

- Built-in with 2pc- EV220-SH lanyard with 2-pcs carabiner & mini energy absorber.
- Conform to BS EN354 & SIRIM certification no: PP071005 for Lanyard; BS EN355 & SIRIM certification no: PP071004 for Energy Absorber.

Product Code:	Packing:
EV250-LOH	1set/box 10sets/carton
EV270-SH	1set/box 10sets/carton

Rope Grab AHRS-1C

Automatically accompany the user without requiring manual adjustment during upward or downward movement.

- Made of aluminium alloy.
- Mobile design with hands free operation.
- Built-in with 1-pc carabiner.
- Works perfectly on 14mm or 16mm diameter vertical lifeline.
- Conform to BS EN353

Product Code:	Weight:	Packing:
AHRS-1C	370gms	1pc/box

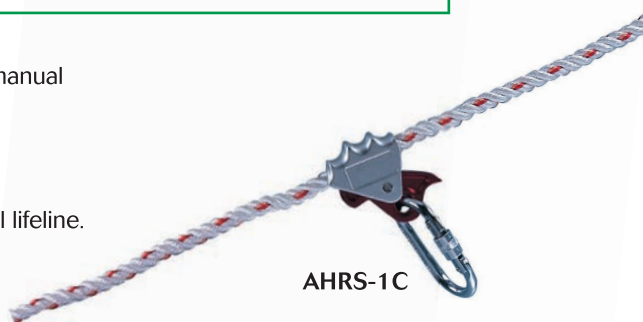

AHRS-1C



FALL PROTECTION EQUIPMENTS

PROGUARD SAFETY PRODUCTS CATALOGUE

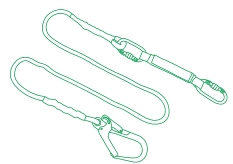

CE
EN353-2



AL736-1410/1420/1430

Vertical Anchor Line AL736-1410/1420/1430

Use with a full body harness for a complete fall protection system when a user moving in a vertical direction. The fall arrestor will locks or arrest a fall automatically when a fall occurs.

- 14mm diameter anchor line is built-in with 1 pc large opening hook, extension lanyard on PG141064 Fall Arrestor with 1-pc snap hook.
- Comes with PG0190 MPB Multi Purpose Bag.
- Conform to BS EN353-2

Product Code:	Size x Length	Packing:
AL736-1410	14mm x 10m	1unit/bag
AL736-1420	14mm x 20m	1unit/bag
AL736-1430	14mm x 30m	1unit/bag

CE
EN795



S790-10 & S790-20

Horizontal Anchorage Lifeline S790-10/ S790-20

Portable horizontal lifeline allows movement sideways with absolute safety. The lifeline should connect horizontally in-between two anchor points and is adjustable with the retractable handle bar.

- Built-in with 1 pc webbing retractable, 1-pc D-ring & 2-pcs carabiner.
- Comes with PG0190 MPB Multi Purpose Bag.
- Conform to BS EN795

Product Code:	Size x Length	Packing:
S790-10	45mm x 10m	1unit/bag
S790-20	45mm x 20m	1unit/bag

Life Line LL738-1410/1420/1430

These life lines are generally used in conjunction with a fall arrestor or a rope grab, giving the freedom of movement up or down, while providing a passive fall arrest system. It can be also use horizontally.

- 14mm diameter anchor line is built-in with 1 pc large opening hook.
- Comes with PG0190 MPB Multi Purpose Bag.
- Conform to BS EN353-2

Product Code:	Size x Length	Packing:
LL738-1410	14mm x 10m	1unit/bag
LL738-1420	14mm x 20m	1unit/bag
LL738-1430	14mm x 30m	1unit/bag



LL738-1610/1620/1630

Life Line LL738-1610/1620/1630

- 16mm diameter anchor line is built-in with 1 pc large opening hook.
- Available in 10 meter, 20 meter & 30 meter.
- Comes with PG0190 MPB Multi Purpose Bag.
- Conform to BS EN353-2

Product Code:	Size x Length	Packing:
LL738-1610	16mm x 10m	1unit/bag
LL738-1620	16mm x 20m	1unit/bag
LL738-1630	16mm x 30m	1unit/bag



CE
EN353-2

LL738-1410/1420/1430

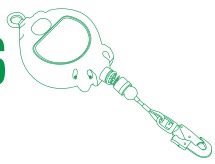

Polyamide Ropes PR12/ PR14/ PR16

Polyamide ropes are the most popular type among synthetic ropes for their abrasion resistance, flex resistance, heat resistance, atmosphere resistance & absorption of energy.

- Made of polyamide 3 strand ropes with indicator orange & black running lines.
- Replace it when the running lines fade which indicates that the lanyard life has worn out.
- Available in 12mm, 14mm & 16mm diameter.

Product Code:	Size x Length	Packing:
PR12	12mm x 100m	1 unit/bag
PR14	14mm x 100m	1 unit/bag
PR16	16mm x 100m	1 unit/bag

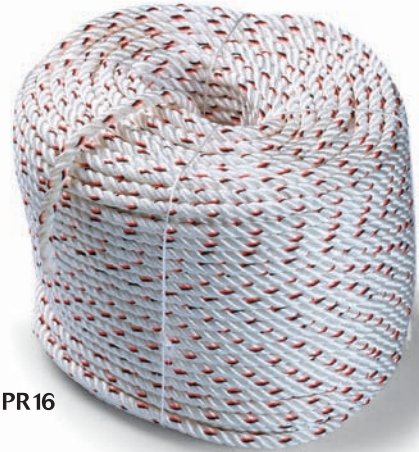

PR12/ PR14/ PR16

Safety Block PCGS10/ PCGS15/ PCGS20

These fall arrester blocks are designed to give the user maximum protection and mobility in working environments where there is risk involved. In the event of an accident fall, the block locks immediately and prevents the user from falling further. The block comes in different models depending on the length.

- Epoxy coated aluminium alloy outer casing.
- Retractable steel cable fall arrester.
- 4mm diameter Steel Cable.
- Built-in with 1-pc eye-bolt & 1-pc press snap hook.
- Available in 10, 15 & 20 meter.
- Conform to BS EN360
- Sold individually.

Product Code:	Maximum Length:	Weight:	Packing:
PCGS10	10m	7kg	1set
PCGS15	15m	7.8kg	1set
PCGS20	20m	8.6kg	1set



CE
EN360

PCGS10/ PCGS15/ PCGS20

Mini Block S110

Usage is similar to safety block but more compact, light & easy to carry.

- Retractable webbing fall arrester incorporating with an energy absorber package.
- Built-in with 1-pc carabiner.
- Conform to BS EN360 & SIRIM certification no: PP071007

Product Code:	Maximum Length:	Weight:	Packing:
S110	2.7m	1.2kg	1set



S110

CE
EN360
MS
SIRIM
CERTIFIED TO BS EN 360 : 2002
Certification No : PP071007

Fall Arrester PG141064

In the event of a fall, it will lock on to the vertical lifeline automatically. Having a unique safe mode is to prevent this fall arrester to be mounted the wrong way.

- Made of high quality steel.
- Conveniently clasped on to any vertical lifeline.
- Equipped with a 20cm webbing strap & with 1-pc press snap hook.
- Inbuilt function to park the device in locked position.
- Works perfectly on 14mm or 16mm diameter vertical lifeline.
- Conform to BS EN353

Product Code:	Weight:	Packing:
PG141064	1100gms	1set/box



PG141064

CE
EN353

FALL PROTECTION EQUIPMENTS

PROGUARD SAFETY PRODUCTS CATALOGUE

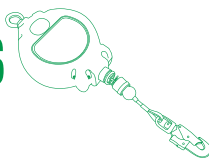

SIRIM
CERTIFIED TO BS EN 362 : 2004
Certification No : PP071009



8400PH

Press Snap Hook 8400PH

Self closing auto locking steel press hook. Can only be opened by least two deliberate manual actions for safety purposes.

- Opening: 20mm
- Static Strength > 22kN
- Conform to BS EN362 & SIRIM certification no: PP071009

Product Code:	Weight:	Packing:
8400PH	250gms	1pc/polybag 6pcs/box



SIRIM
CERTIFIED TO BS EN 362 : 2004
Certification No : PP071009



8231

Large Opening Hook 8231

Self closing auto locking steel forged hook. Can only be opened by least two deliberate manual actions for safety purposes.

- Opening: 53mm
- Static Strength > 22kN
- Conform to BS EN362 & SIRIM certification no: PP071009

Product Code:	Weight:	Packing:
8231PH	380gms	1pc/polybag 6pcs/box

Triangle Shape Quick Link 2303

Manually locking steel quick link. Suitable to install with energy absorber or to lanyards & directly incorporating with any full body harness.

- Material: Zinc-plated steel
- Opening: 10mm
- Static Strength > 22kN
- Conform to BS EN362

Product Code:	Weight:	Packing:
2303	90gms	1pc/polybag



2303



SIRIM
CERTIFIED TO BS EN 362 : 2004
Certification No : PP071009



800

Safety Carabiner 800

Self closing steel carabiner comes with aluminium quarter turn manual screw locking system. Suitable to install with energy absorber, lanyards or any fall protection accessories & also directly incorporating with any full body harness.

- Material: Zinc-plated alloy steel
- Opening: 20mm
- Static Strength > 22kN
- Conform to BS EN362 & SIRIM certification no: PP071009

Product Code:	Weight:	Packing:
800	166gms	1pc/polybag 10pcs/box

S41-53/PN800



W7370-08

Pear Quick Link W7370-08

Manually locking steel quick link. Suitable to install with energy absorber or lanyard & directly incorporating with any full body harness.

- Material: Zinc-plated steel
- Opening: 15mm
- Static Strength > 22kN
- Conform to BS EN362

Product Code:	Weight:	Packing:
W7370-08	106gms	1pc/polybag



SIRIM
CERTIFIED TO BS EN 795 : 1997
Certification No : PP071008

Tripod S41-53/PN800

For access into confined spaces. To be used to raise or lowering of personal or material into confined spaces.

- Fully adjustable aluminium telescopic legs with steel chain.
- Aluminium alloy cast head.
- 6 height adjustment from 1.75m to 2.5m
- 2 anchorage point with rubber stopper under each foot.
- Equipped with bolting fixture for robust fitting the winch onto the tripod.
- Lifting load capacity: 250kg
- Winch length: 20 meter
- Conform to BS EN795 & SIRIM certification no: PP071008

Product Code:	Weight:	Packing:
S41-53/PN800	31kgs	1unit/bag

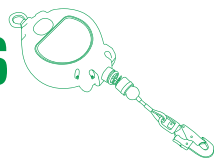

CE
EN795



SIRIM
CERTIFIED TO BS EN 795 : 1997
Certification No : PP071008



S797

Anchor Wire S797

Stainless steel wire rope with both end loop with 1-pc carabiner to create an anchorage point in areas where a direct connection is not available.

- Material: Stainless steel wire.
- Strength 30kN
- Conform to BS EN795 & SIRIM certification no: PP071008
- Sold individually.

Product Code:	Length:	Packing:
S797	1meter	1pc

Anchor Webb S798

Webbing strap with D-ring at one end & a loop at the other end to create a mobile anchorage point in areas where a direct connection is not available.

- Material: 45mm webbing.
- Strength 22kN
- Conform to BS EN795 & SIRIM certification no: PP071008

Product Code:	Length:	Packing:
S798	1meter	1pc



S798

CE
EN795



SIRIM
CERTIFIED TO BS EN 795 : 1997
Certification No : PP071008

CE
EN795



SIRIM
CERTIFIED TO BS EN 795 : 1997
Certification No : PP071008



S799

Anchor Sling S799

Endless webbing sling to create an anchorage point in areas where a direct connection is not available.

- Material: 45mm folded webbing.
- Strength 22kN
- Conform to BS EN795 & SIRIM certification no: PP071008

Product Code:	Length:	Packing:
S799	1meter	1pc

Anchorage Connector S427

High strength anchorage point with wide girder grip. Can be used on beams and pipe. Self locking auto lock hook.

- Material: Stainless steel.
- Opening: 75mm
- Strength 28kN
- Conform to BS EN362 & SIRIM certification no: PP071009

Product Code:	Weight:	Packing:
S427	380gms	1pc

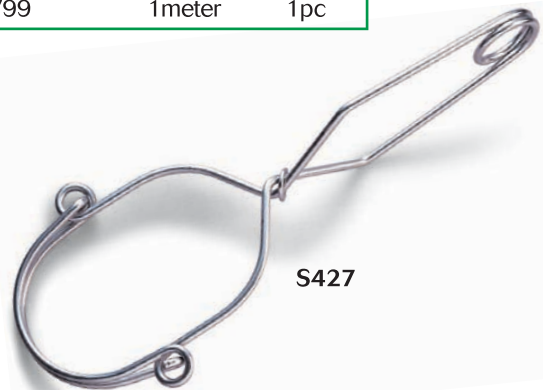

S427

CE
EN362



SIRIM
CERTIFIED TO BS EN 362 : 2004
Certification No : PP071009

Multi Purpose Bag PG 0180-MPB/ PG 0190-MPB

Made of polyester fabric materials and is waterproof resistant. These bags are to store, to well keep & also to protect their full body harness, hooks, lanyards & other accessories in good condition after each uses.

Product Code:	Closure:	Packing:
PG 0180-MPB	Zipper	1pc/polybag
PG 0190-MPB	String with stopper	1pc/polybag



PG 0190-MPB



PG 0180-MPB



MLJ-CN

Economic Marine Life Jacket MLJ-CN

- These economic life jackets are to help you to remain in a position which permits proper breathing and to stay afloat.
- 2 pcs x 25mm waist straps.
- A whistle to attract attention during emergency.
- Lightweight & easy to wear.
- Standard retroreflective material on shoulder.

Marine Life Jacket SLJ-MY

- These marine life jackets with collar are to keep your head above water and to help you to remain in a position which permits proper breathing and to stay afloat.
- Buoyancy can be found on both front & back in separate compartments, making movement & wearing the vest easily.
- 2 pcs x 40mm waist straps & 1 pc crutch strap.
- A whistle to attract attention during emergency.
- Lightweight & easy to wear.
- Standard mirco-prismatic reflective material on collar.
- Size: S,M,L,XL,XXL

SIRIM Test Report
No: 2005MA0686



SLJ-MY

Marine Life Jacket PLJ-MY

- These premium marine life jackets with wider collar are to keep your head above water and to help you to remain in a position which permits proper breathing and to stay afloat.
- Buoyancy can be found on both front & back in separate compartments, making movement & wearing the vest easily.
- 2 pcs x 50mm waist straps & 1 pc crutch strap.
- A whistle to attract attention during emergency.
- Lightweight & easy to wear.
- Standard mirco-prismatic reflective material on collar & chest.
- Size: S,M,L,XL,XXL



PLJ-MY

Product Code:	Colour:	Size:	Packing:
MLJ-CN	Din Orange	Free	1pc/polybag
SLJ-MY	Din Orange	Free	1pc/polybag
PLJ-MY	Din Orange	Free	1pc/polybag



ST-3620

Heavy Duty Visibility Rainsuit with High Reflective Strips

ST-3620

- 2-pcs: Jacket & Trouser
- Light, compact, flexible, safe & superior quality.
- Made of 0.30mm PVC on polyester broadloom fabric.
- Jacket features non-detachable drawstring hood which can fits over safety cap. Front zipper and extra flap for extra waterproofing & protection. Ventilation cape & 2 front waist pocket.
- Waist pants feature with elastic band for multiple waist sizes.
- All snap-on buttons are non-conductive, corrosive and rustproof.
- Combination of Brite-safe yellow & orange colour with 25mm reflective strip around the waist, arms & knees for excellent high visibility.
- Malaysia Design No: 01-00352

Product Code:	Size:	Packing:
ST-3620	M, L, XL, 2XL	1set/polybag 20set/carton

Heavy Duty Visibility Raincoat with High Reflective Strips

ST-3580

- 1-pc: Knee-length Coat
- Light, compact, flexible, safe & superior quality.
- Made of 0.30mm PVC on polyester broadloom fabric.
- Non-detachable drawstring hood which can fits over safety cap. Ventilation cape & 2 front waist pocket.
- All snap-on buttons are non-conductive, corrosive and rustproof.
- Combination of Brite-safe yellow & orange colour with 25mm reflective strip around the waist & arms for excellent high visibility.
- Malaysia Design No: 01-00351

Product Code:	Size:	Packing:
ST-3580	M, L, XL, 2XL	1set/polybag 20set/carton



ST-3580



RC-8020

Heavy Duty Visibility Rainsuit RC-8020

- 2-pcs: Jacket & Trouser
- Light, compact, flexible, safe & superior quality.
- Made of 0.30mm PVC on polyester broadloom fabric.
- Jacket features non-detachable drawstring hood which can fits over safety cap. Front zipper and extra flap for extra waterproofing & protection. Ventilation cape & 2 front waist pocket.
- Waist pants feature with elastic band for multiple waist sizes.
- All snap-on buttons are non-conductive, corrosive and rustproof.
- Brite-safe yellow colour for excellent high visibility.

Product Code:	Size:	Packing:
RC-8020	M, L, XL, 2XL	1set/polybag 20set/carton



RC-8018

Heavy Duty Visibility Raincoat RC-8018

- 1-pc: Knee-length Coat
- Light, compact, flexible, safe & superior quality.
- Made of 0.30mm PVC on polyester broadloom fabric.
- Non-detachable drawstring hood which can fits over safety cap. Ventilation cape & 2 front waist pocket.
- All snap-on buttons are non-conductive, corrosive and rustproof.
- Brite-safe yellow colour for excellent high visibility.

Product Code:	Size:	Packing:
RC-8018	M, L, XL, 2XL	1set/polybag 20set/carton



ST-3600

Heavy Duty Boiler Suit ST-3600

- 1-pc: Coverall
- Made of PVC coated with nylon based material.
- Comfortable, flexible, safe and superior in quality.
- Excellent chemical resistant.
- Features non-detachable drawstring hood which can fits over safety cap. Front zipper and extra flap for extra waterproofing & protection.
- All snap-on buttons are non-conductive, corrosive and rustproof.
- Green colour provide good visibility.

Product Code:	Size:	Packing:
ST-3600	M, L, XL, 2XL	1set/polybag 20set/carton



CVNW-PE



CVNW

Multi-Purpose Disposable Workwear CVNW-PE/ CVNW

- 1-pc: Coverall
- Anti-static, water & alcohol repellent.
- Protection against dust, water base liquid, oil, grease, blood, saline, diluted chemical & etc.
- Soft & lightweight fabric and freedom of movement.
- Cool & comfortable elastic waist, cuff and ankle.
- Ideal for painting, spraying, planting, cleanroom environment, electronic industries, pharmaceuticals, biomedical research, agricultural, forensic work, oil & solvent handling, washing and many others light duty task.
- Available with or without PE coating.

Product Code:	Size:	Packing:
CVNW-PE	M, L, XL, 2XL	1set/polybag 20set/carton
CVNW	M, L, XL, 2XL	1set/polybag 20set/carton



Kleenguard XP

Kleenguard XP Protective Coverall

- Manufacturer using breathable fabric ensuring user comfort and safety.
- Film laminated technology provides an outstanding barrier against wide range of chemicals.
- Ultra low-lint performance as the result of the film laminate and internal seams.
- Meet the requirements of EU standard CE0120 for garment offering Type 6 & Type 5 protection.
- 1pc/polybag 25pcs/carton

Product Code:	Size:	Packing:
Kleenguard XP	M, L, XL	1set/polybag 20set/carton



Kleenguard A30

Kleenguard A30 Extra Protective Coverall

- 1-pc: Coverall
- Made of PVC coated with nylon based material.
- Comfortable, flexible, safe and superior in quality.
- Excellent chemical resistant.
- Features non-detachable.

Product Code:	Size:	Packing:
Kleenguard A30	M, L, XL	1set/polybag 25set/carton

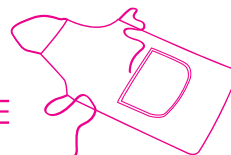

Bouffant Cap TPNW

- Made of spunbonded non woven polypropylene.
- Ideal for food industry, pharmaceuticals, cleanroom, electronic industries and many more.

TPNW



ASNW

Shoecover ASNW

- Made of spunbonded non woven polypropylene.
- Ideal for pharmaceuticals, cleanroom and electronic industries.

Product Code:	Size:	Packing:
TPNW	Free	100pcs/box 5box/carton
ASNW	Free	50prs/pkt 250prs/carton



Cotton Jacket

- Made of 100% cotton.
- Pre-shrunk material to protect against high percentage of shrinkage.
- Long sleeve, front button, 2 waist pockets with flaps and buttons.
- Size can be worn over cloths.
- Embroidery corporate logo or identity service on jacket can be arrange upon request.

Product Code:	Colour:	Size:	Packing:
CJNB	Navy Blue	S, M, L, XL, 2XL	1pc/polybag 20pcs/carton
CJO	Orange	S, M, L, XL, 2XL	1pc/polybag 20pcs/carton
CJLB	Light Blue	S, M, L, XL, 2XL	1pc/polybag 20pcs/carton
CJGR	Gray	S, M, L, XL, 2XL	1pc/polybag 20pcs/carton

Cotton Coverall

- Designed for durability and made of 100% cotton for coolness and comfort.
- Pre-shrunk material to protect against high percentage of shrinkage.
- Full-front 2-way zipper closure, elastic waistband, two lower pockets with flaps and buttons.
- Size can be worn over cloths.
- Embroidery corporate logo or identity service on jacket can be arranged upon request.
- Other colours also available upon request.

Product Code:	Colour:	Size:	Packing:
CCNB	Navy Blue	S, M, L, XL, 2XL, 3XL	1set/polybag 20sets/carton
CCO	Orange	S, M, L, XL, 2XL, 3XL	1set/polybag 20sets/carton
CCY	Yellow	S, M, L, XL, 2XL, 3XL	1set/polybag 20sets/carton
CCLB	Light Blue	S, M, L, XL, 2XL, 3XL	1set/polybag 20sets/carton
CCR	Red	S, M, L, XL, 2XL, 3XL	1set/polybag 20sets/carton
CCGR	Gray	S, M, L, XL, 2XL, 3XL	1set/polybag 20sets/carton



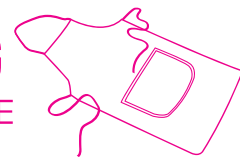

Economic Coverall

- Made of 100% cotton.
- Economic version workwear with pre-shrunk material to protect against high percentage of shrinkage.
- Full-front 2-way zipper closure, elastic waistband, two lower pockets with flaps and buttons.
- Size can be worn over cloths.
- Embroidery corporate logo or identity service on jacket can be arranged upon request.
- Other colours also available upon request.

Product Code:	Colour:	Size:	Packing:	
ES-ECNB	Navy Blue	S, M, L, XL, 2XL, 3XL	1set/polybag	20sets/carton
ES-ECO	Orange	S, M, L, XL, 2XL, 3XL	1set/polybag	20sets/carton



Fire Retardant Cotton Coverall

- These flame-resistant garments protect the wearer from heat & flame of flash fire, providing valuable seconds of protection for escape and minimizing the potential burn injury.
- The effectiveness of NOMEX-III/A protecting against serious burn injury has been well documented in laboratories, field tests & real-life fire situation.
- Inherently flame-resistant, high temperature fiber that does not melt, burn or support combustion in air. This protection is permanent which cannot be washed out or worn away.
- Other colours also available upon request.

Product Code:	Colour:	Size:	Packing:	
FRCNB	Navy Blue	S, M, L, XL, 2XL, 3XL	1set/polybag	20sets/carton
FRCR	Orange	S, M, L, XL, 2XL, 3XL	1set/polybag	20sets/carton
FRCY	Yellow	S, M, L, XL, 2XL, 3XL	1set/polybag	20sets/carton
FRCG	Green	S, M, L, XL, 2XL, 3XL	1set/polybag	20sets/carton

Embroidery Services

PROGUARD can provide embroidery services for badges & logo to your requirements. Many of our featured clothing products can be embroidered by our experienced team offering the best method to suit your corporate image. Contact us for further details.

Product Code:	Description:
EA-CS1	Embroidery Artwork
UE-CS2	Uniform Embroidery
BE-CS3	Badge Embroidery

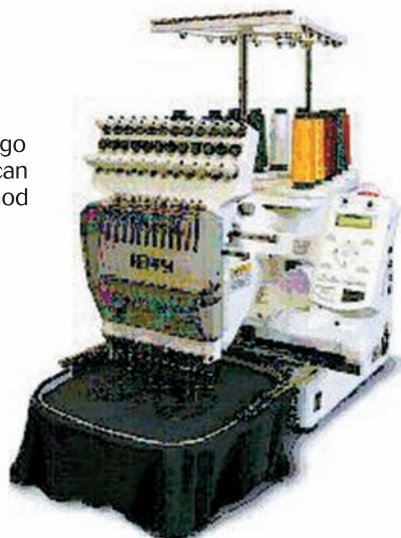

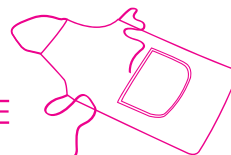

WPG-218



HPA/ALU/3048

Leather Protective Apron WPG-218

These aprons are made of quality spilt cow leather sew-on adjustable neck loop and waist ties. Provides ample body protection and extremely lightness.

Heat Resistant Apron HPA/ ALU/ 3048

Made of Aramid & Aluminized Fabric with strong sew-on neck loop and waist ties. Provides high thermal insulation and extremely lightness.

Product Code:	Size:	Packing:
WPG-218	24" x 36"	1pc/polybag
HPA/ALU/3048	30" x 48"	1pc/polybag

Leather Protective Sleeve WPG-221

These sleeves are made of quality spilt cow leather sew-on adjustable shoulder straps. Provides protection against welding sparks and extremely lightness.

Heat Resistant Sleeve HPS/ ALU/ 22

These sleeves are made of Aramid & Aluminized Fabric sew-on adjustable shoulder straps. Provides high thermal insulation and extremely lightness.

Product Code:	Length:	Size:	Packing:
WPG-221	24"	Free	1pc/polybag
HPS/ALU/22	22"	Free	1pc/polybag



WPG-221



HPS/ALU/22



PLNW

PVC Oversleeve PLNW

These sleeves are made of 100% PVC. All seam on the sleeve are electrically welded for excellent protection & eliminate leaks Ideal for chemical handling, agricultural, janitorial & etc.

Product Code:	Length:	Size:	Packing:
PLNW	40cm	Free	100pcs/pkt 10pkt/carton



CPDA-LDPE-W

CPDA-LDPE-B

Economic LDPE Apron CPDA-LDPE-W/ CPDA-LDPE-B

Light duty & economical. Larger size for maximum coverage. Excellent waterproof, extra soft and comfortable.

Product Code:	Size:	Thickness:	Packing:
CPDA-LDPE-W	28"x55"	0.02mm	100pcs/pkt 10pkt/carton
CPDA-LDPE-B	28"x55"	0.02mm	100pcs/pkt 10pkt/carton

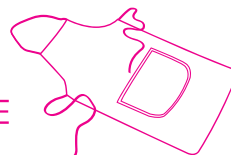

Welding Leather Jacket WPG-222

These welding jackets are made of quality cow grain leather with two vertical level buttons for adjustable sizes. Provides excellent body protection against heat, welding sparks & harmful welding rays.

Welding Leather Trouser WPG-223

These welding trousers are made of quality cow grain leather with elastic straps & buckles. Provides excellent leg protection against heat, welding sparks & harmful welding rays.

Welding Leather Foot Guard WPG-225

These welding foot guards are made of quality spilt leather with leather straps & buckles. Provides excellent foot protection against heat, welding sparks & harmful welding rays.

Product Code:	Size:	Packing:
WPG-222	Free	1set/polybag
WPG-223	Free	1pr/polybag
WPG-225	Free	1pr/polybag

WPG-223

WPG-225

Poly-Vinyl Apron ST-3990

Extremely light and flexible with great resistant to chemicals fats, oils and grease. Versatile splash protection and suitable for all general application.

Heavy Duty Poly-Vinyl Apron ST-3880

Made of 0.30mm PVC on polyester broadloom fabric with great resistant to chemicals fats, oils and grease. Versatile splash protection and suitable for heavy duty application.

Product Code:	Size:	Packing:
ST-3990	27" x 36"	1pc/polybag
ST-3880	28" x 40"	1pc/polybag



ST-3990



ST-3880

Synthetic Leather Apron SLA-PU

These aprons are made of high quality synthetic PU leather with sew-on neck loop, waist ties and waist pouch. Provides ample body protection and abrasion proof.

Furniture Leather Apron A100E

These assorted colour aprons are made of high quality leather with leather sew-on adjustable neck loop and waist ties. Provides ample body protection and extremely lightness.

Product Code:	Size:	Packing:
SLA-PU	20" x 35"	1pc/polybag
A100E	24" x 35"	1pc/polybag

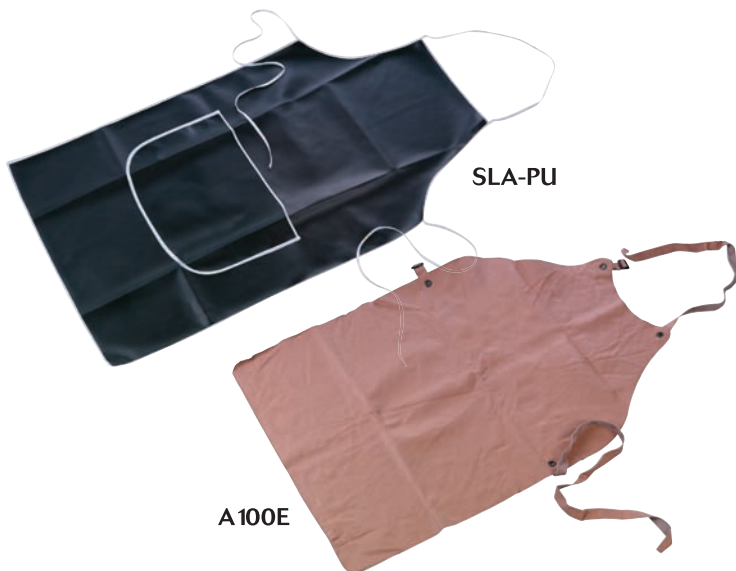

SLA-PU

A100E

SAFETY VEST

PROGUARD SAFETY PRODUCTS CATALOGUE

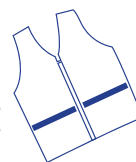

NSV300LG/ NSV300DO

Economic Safety Vest NSV300LG/ NSV300DO

- Velcro fastener with black bidding to garment edges.
- Vertical stitched general reflective material size: 25mm x 150mm
- Light weight, general usage and washable.

Product Code:	Colour/ Type:	Size:	Packing:
NSV300LG	Lime Green/ Netting Fabric	Free	1pc/polybag 50pcs/carton
NSV300DO	Din Orange/ Netting Fabric	Free	1pc/polybag 50pcs/carton

Safety Vest TC-301

- Velcro fastener with black bidding to garment edges.
- Vertical stitched with high gloss visibility reflective material size: 25mm x 150mm
- Light weight, hard wearing usage and washable.



TC-301



TC-302HG1

Safety Vest TC-302HG1

- Zipper fastener with black bidding to garment edges.
- Horizontal stitched with high gloss visibility reflective material 1pc x 50mm bodyband.
- Fabric conforms to EN471
- Light weight, hard wearing usage and washable.

Product Code:	Colour/ Type:	Size:	Packing:
TC-301	High Visibility Yellow/ Polyester Waistcoat	Free	1pc/polybag 50pcs/carton
TC-302HG1	High Visibility Yellow/ Polyester Waistcoat	Free	1pc/polybag 50pcs/carton

High Visibility LED Safety Vest SV-7170-LED

- Button fastener with orange bidding to garment edges.
- EN471 approved mirco-prismatic reflective material with 1pc x 50mm horizontal stitched bodyband and 2pcs x 50mm vertical brace with LED twinkling lights in front & back which operated by an on/off switch run by 2pcs "AAA" batteries (Batteries not included)
- 3V batteries can run estimated 280 hrs
- Light weight, hard wearing usage.
- Meets EN471 Class 2

Product Code:	Colour/ Type:	Size:	Packing:
SV-7170-LED	Din Orange/ Mesh Fabric	Free	1pc/polybag 50pcs/carton



SV-7170-LED

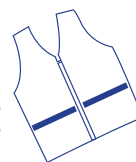

TC-VH3-HG

High Visibility Safety Vest TC-VH3-HG

- Zipper fastener with black bidding to garment edges.
- EN471 approved mirco-prismatic reflective material with 1pc x 50mm horizontal stitched bodyband and 2pcs x 50mm vertical brace.
- Light weight, hard wearing usage and washable.
- Meets EN471 Class 2



TC-VH3-FRM

High Visibility Safety Vest TC-VH3-FRM

- Zipper fastener with black bidding to garment edges.
- EN471 approved retroreflective material with 1pc x 50mm horizontal stitched bodyband and 2pcs x 50mm vertical brace.
- Light weight, hard wearing usage and washable.
- Meets EN471 Class 2

Product Code:	Colour/ Type:	Size:	Packing:
TC-VH3-HG	High Visibility Yellow/ Polyester Waistcoat	M, L, XL, 2XL	1pc/polybag 50pcs/carton
TC-VH3-FRM	High Visibility Yellow/ Polyester Waistcoat	M, L, XL, 2XL	1pc/polybag 50pcs/carton

High Visibility Safety Vest TC-VH4-HG

- Zipper fastener with black bidding to garment edges.
- EN471 approved mirco-prismatic reflective material with 2pcs x 50mm horizontal stitched bodyband and 2pcs x 50mm vertical brace.
- Light weight, hard wearing usage and washable.
- Meets EN471 Class 2



TC-VH4-HG

High Visibility Safety Vest TC-VH4-FRM

- Zipper fastener with black bidding to garment edges.
- EN471 approved retroreflective material with 2pc x 50mm horizontal stitched bodyband and 2pcs x 50mm vertical brace.
- Light weight, hard wearing usage and washable.
- Meets EN471 Class 2



TC-VH4-FRM

Product Code:	Colour/ Type:	Size:	Packing:
TC-VH4-HG	High Visibility Yellow/ Polyester Waistcoat	M, L, XL, 2XL	1pc/polybag 50pcs/carton
TC-VH4-FRM	High Visibility Yellow/ Polyester Waistcoat	M, L, XL, 2XL	1pc/polybag 50pcs/carton

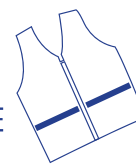

TC-302-HG2

High Visibility Safety Vest TC-302-HG2

- Zipper fastener with black bidding to garment edges.
- EN471 approved mirco-prismatic reflective material with 2pcs x 50mm horizontal stitched bodyband.
- Light weight, hard wearing usage and washable.
- Meets EN471 Class 2



TC-302-FRM

High Visibility Safety Vest TC-302-FRM

- Zipper fastener with black bidding to garment edges.
- EN471 approved retroreflective material with 2pcs x 50mm horizontal stitched bodyband.
- Light weight, hard wearing usage and washable.
- Meets EN471 Class 2

Product Code:	Colour/ Type:	Size:	Packing:
TC-302-HG2	High Visibility Yellow/ Polyester Waistcoat	M, L, XL, 2XL	1pc/polybag 50pcs/carton
TC-302-FRM	High Visibility Yellow/ Polyester Waistcoat	M, L, XL, 2XL	1pc/polybag 50pcs/carton

High Visibility Safety Vest TCOR-302-HG2

- Zipper fastener with black bidding to garment edges.
- EN471 approved mirco-prismatic reflective material with 2pcs x 50mm horizontal stitched bodyband.
- Fabric conforms to EN471
- Light weight, hard wearing usage and washable.
- Meets EN471 Class 2



TCOR-302-HG2

High Visibility Safety Vest TCOR-302-FRM

- Zipper fastener with black bidding to garment edges.
- EN471 approved mirco-prismatic reflective material with 2pc x 50mm horizontal stitched bodyband and 2pcs x 50mm vertical brace.
- Light weight, hard wearing usage and washable.
- Meets EN471 Class 2



TCOR-VH4-HG

Product Code:	Colour/ Type:	Size:	Packing:
TCOR-302-HG2	Din Orange/ Polyester Waistcoat	M, L, XL, 2XL	1pc/polybag 50pcs/carton
TCOR-VH4-HG	Din Orange/ Polyester Waistcoat	M, L, XL, 2XL	1pc/polybag 50pcs/carton



CM-SS-600/ 800/ 1000

Badge Marking Services

- Our range of high reflective vest can be custom printed onto reflective badges or reflective fabrics to personalize company logos, names or services.

Stainless Steel Convex Mirror CM-SS-600/ 800/ 1000

Polished stainless steel mirror face with stainless steel back to withstand the harshest environmental conditions. Provides excellent view to avoid collision with vehicles to reduce losses, accident and injuries. Good for use in traffic purposes such as cross-roads, intersection, blind corners and etc.

- Fully stainless steel.
- Durability under extreme weather condition.
- Come with orange surrounding for better visibility.
- Standard bracket for both pole & wall.

Product Code:	Description:	Packing:
CM-SS-600	600mm (24") Stainless Steel Convex Mirror	1set/ box
CM-SS-800	800mm (32") Stainless Steel Convex Mirror	1set/ box
CM-SS-1000	1000mm (36") Stainless Steel Convex Mirror	1set/ box



Indoor & Outdoor Convex Mirror CM-PC-600/ 800/ 1000

Lightweight, high impact & scratch resistant polycarbonate mirror which provides the highest quality and the brightest of images with less distortion. Provided excellent safety view to avoid shop-lifting & collision with vehicles to reduce losses, accident and injuries. Good for use in traffic purposes such as cross-roads, intersection, blind corners and etc.

- 1-pc compound backboard and moisture resistant to increase mirror life.
- Durability under extreme weather condition.
- Come with orange surrounding for better visibility.
- Standard bracket for both pole & wall.

Product Code:	Description:	Packing:
CM-PC-600	600mm (24") Convex Mirror	1set/ box 5sets/carton
CM-PC-800	800mm (32") Convex Mirror	1set/ box
CM-PC-1000	1000mm (36") Convex Mirror	1set/ box



CM-PC-600/ 800/ 1000



High Visibility Emergency Traffic Baton J-002/ J-003/ J-005

These batons are hand held, battery powered warning light wand. Designed as a durable, quality built essential equipment for crowd and traffic control. Quickly attracts attention and has found wide acceptance by police, emergency medical crews, fire departments, rescue, safety & industrial personnel.

- Superb bright emergency light with torch light.
- Impact & weather resistant.
- 2-section – Blinking & Static modes.
- Excellent day & night visibility.
- Non-slip designed handle with wrist strap.
- Water resistant on/off button.



J-002



J-003



J-005

Product Code:	Description:	Packing:
J-002	Fit with 2pcs size C batteries Dimension 30 x 180 x 360mm	1pc/box
J-003	Fit with 2pcs size C batteries Dimension 30 x 335 x 535mm	1pc/box
J-005	Fit with 2pcs size D batteries Dimension 40 x 345 x 560mm	1pc/box



SH-125-65

Personal Blinker SH-125-65

Make yourself seen with this personal blinker. LED illumination provide a visibility on a clear night.

- Six flashing modes with a belt mounting attachment.
- At least 150 hours of continuous operation on two AA batteries (battery not included)

Product Code:	Colour/Type:	Packing:
SH-125-65	Personal Blinker	1pc/polybag

Surelite Hazard Warning Light TBL-LED-A/ TBL-LED-R

An excellent product for road construction, utility crews, emergency response personnel for quick, reliable deployment to highlighting obstacles and danger in hazardous area. Suitable for wide range of uses and ability to survive even the roughest conditions. It has a light dependant resistor which will detect when darkness falls and accordingly activate the lamp. Equally, when the light levels increase, the lamp will automatically switch off, conserving battery energy.

- Daylight cut-out mode selectable.
- Ultra bright light source.
- 120 to 150 flashes per minute.
- Large lens (185mm) for excellent visibility.
- Bi-directional lens arrangement.
- Effective demarcation of hazardous area zone.
- Fit with single or double 4R25 (6V) battery. (battery sold separately)

Product Code:	Description:	Packing:
TBL-LED-A	Hazard Warning Lamp Lens Colour: Amber	1pc/box 10pcs/carton
TBL-LED-R	Hazard Warning Lamp Lens Colour: Red	1pc/box 10pcs/carton



TBL-LED-A



TBL-LED-R



CTL-LED-A



CTL-LED-R

Surelite Cone Hazard Warning Light CTL-LED-A/ CTL-LED-R

These CTL series is similar as TBL series but with handle adapter and direct on/off switch. These cone type warning lights are easily mounting onto standard traffic cones.

- Daylight cut-out mode selectable.
- Ultra bright light source.
- 120 to 150 flashes per minute.
- Large lens (185mm) for excellent visibility.
- Bi-directional lens arrangement.
- Effective demarcation of hazardous area zone.
- Fit with two size D batteries. (battery sold separately)

Product Code:	Description:	Packing:
CTL-LED-A	Hazard Warning Lamp Lens Colour: Amber	1pc/box 10pcs/carton
CTL-LED-R	Hazard Warning Lamp Lens Colour: Red	1pc/box 10pcs/carton

TRAFFIC CONTROL EQUIPMENTS

PROGUARD SAFETY PRODUCTS CATALOGUE



Surelite Cone Hazard Warning Light CHB-LED-R

These CHB series is similar as CTL series but with slimmer body & smaller lens. These cone type warning lights are easily mounting onto standard traffic cones.

- Daylight cut-out mode selectable.
- Ultra bright light source.
- Lens size 95mm.
- Effective demarcation of hazardous area zone.
- Fit with two size D batteries. (battery sold separately)

Product Code:	Description:	Packing:
CHB-LED-R	Hazard Warning Lamp Lens Colour: Red	1pc/box 10pcs/carton



CHB-LED-R



LB6V

Lantern Battery LB6V

Carbon zinc battery. Voltage rating: 6V Terminal type: top spring loaded.

Product Code:	Description:	Packing:
LB6V	Lantern Battery	Sold individually 24pcs/carton



TC-18



TC-30



TC-24

Traffic Cones TC-18/ TC-30/ TC-24

Place traffic cones inside, outside or anywhere you want to create a smooth flow of vehicle and pedestrian traffic. Rugged and durable. Cones feature a square & triangle for maximum stability – they won't tip over in the wind or roll away if knocked over. Great choice for use during day, night, in the dark or gloomy condition.

- Moulded using high durability HDPE material.
- Cone & base are one continuous layer to prevent tearing & base separation.
- Brilliant red-orange with UV stabilized to keep colour from fading.
- Easy stacking.
- Sand base.

Product Code:	Description:	Packing:
TC-18	18" Cylinder Shape Traffic Cone	Sold individually
TC-30	30" Cylinder Shape Traffic Cone	Sold individually
TC-24	24" Triangle Shape Traffic Cone	Sold individually

Retractable Safety Cones RSC24BL/ RSC28BL

These cones are fully retractable. Flashing light mounted on the top of the cone. The light is stored at the bottom of the platform when not in use. Great choice for use during day, night, in the dark or gloomy condition.

- Base are made by ABS.
- Manufacturer with durable waterproof nylon dinear material with 1 pc retroreflective material.
- Easy storage in a carrying bag when not in use.

Product Code:	Description:	Packing:
RSC24BL	24" Retractable Safety Cone	1pc/bag 10pcs/carton
RSC28BL	28" Retractable Safety Cone	1pc/bag 10pcs/carton



RSC24BL

RSC28BL



FTC-O

Flexibar FTC-O

These flexibar are weather resistance with excellent reboundable properties & great impact resistance. Groove area for better protection on the reflective tapes. Bigger diameter post and brighter colour for excellent visibility. Simple mounting by adhesive or by bolting.

- Made of EDPM rubber.
- Post dia: 80mm x 710mm
- Base dia: 210mm x 50mm

Product Code:	Description:	Packing:
FTC-O	Flexibar	1-pc

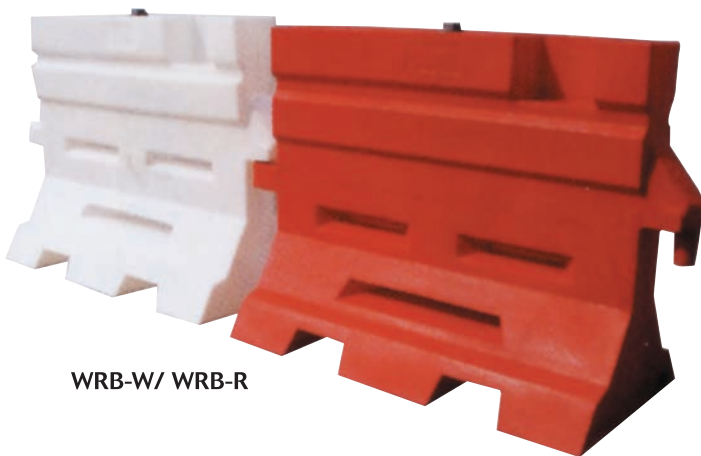

WRB-W/ WRB-R

Warning Road Barrier WRB-W/ WRB-R

Act as traffic safety barriers for channeling vehicles or pedestrian traffic. Excellent visibility.

- Made of Polyethylene.
- Lightweight, transportable & water-filled.

Product Code:	Description:	Packing:
WRB-W	Warning Road Barrier Colour: White	1unit
WRB-R	Warning Road Barrier Colour: Red	1unit



WBF-DO

Warning Barrier Fence WBF-DO

To control crowds & traffic around construction sites. Can also be use in industrial facilities, chemical spill areas and other sites when caution must be practiced. This barricade is hard to miss for its excellent visibility.

- Made of Polyethylene.
- 1meter height x 30.48m length.

Product Code:	Description:	Packing:
WBF-DO	Warning Barrier Fence Colour: Din Orange	1 roll
WBF-y	Warning Barrier Fence Colour: Yellow	1 roll

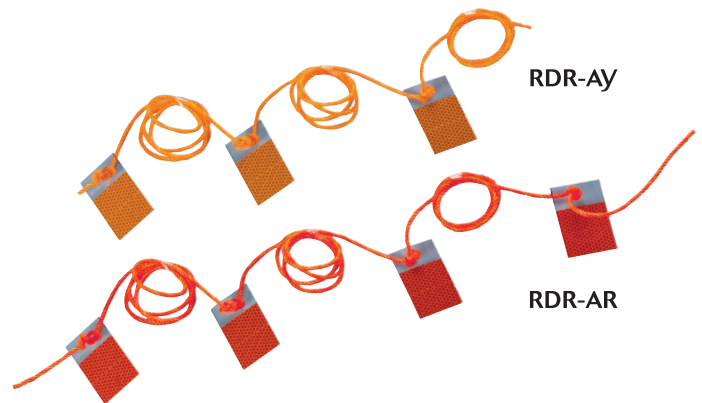

RDR-AY

RDR-AR

Reflective Delineator Rope RDR-AY/ RDR-AR

These delineator ropes can be used to control crowds & to direct traffic or marking dangerous areas. Excellent visibility.

- 2" x 2" reflective stickers.
- 4mm rope diameter x 50m length.

Product Code:	Description:	Packing:
RDR-AY	Reflective Delineator Rope Colour: Yellow reflective	1roll
RDR-AR	Reflective Delineator Rope Colour: Red reflective	1roll
RDR-CRS	Reflective Delineator Rope Colour: Red/Silver reflective	1roll
RDR-CYR	Reflective Delineator Rope Colour: Yellow/Red reflective	1roll



CE
EN ISO 20345



R219MSTC



R291MSTC

R219STC

R291STC

Safety Wellington Boots R219STC/ R219MSTC/ R291STC/ R291MSTC

These extra heavy duty knee length waterproof safety boots are made to comply EN ISO 20345 specification for safety and durability under all conditions. Fully lined.

- Material used are resistant to fats, acids, oils, solvent and many other chemicals.
- Specially designed cleated sole for high slip resistance, maximum water dispersion and soil release.
- Knitted liner dries quickly for maximum hygiene.
- Optimal toe spring minimizes cracking at flex points while ensuring the boots is easy and comfortable to walk with.
- Height: 370mm to 395mm
- Size: 4 – 13



• for MSTC



• for STC

Product Code: R219STC	Description: Safety Wellington Boots With steel toe cap	Colour: Yellow/Black	Packing: 1pr/polybag 6prs/carton
R219MSTC	Safety Wellington Boots With steel toe cap & steel midsole	Yellow/Black	1pr/polybag 6prs/carton
Product Code: R291STC	Description: Safety Wellington Boots With steel toe cap	Colour: Black/Yellow	Packing: 1pr/polybag 6prs/carton
R291MSTC	Safety Wellington Boots With steel toe cap & steel midsole	Black/Yellow	1pr/polybag 6prs/carton

Wellington Boots 6000W-L/ 6000W/ 6000B-L/ 6000B

Perfect for all type of general industries, agricultural, food industries, gardening & etc. Usefully in wet, muddy and slippery conditions.

- Made of injection PVC.
- Both fully lined & unlined.
- Height: 295mm to 320mm
- Size: 4 – 11



Product Code: 6000W-L 6000W	Description: Lined Wellington Boots Unlined Wellington Boots	Colour: White White	Packing: 1pr/polybag 10prs/carton 1pr/polybag 10prs/carton
Product Code: 6000B-L 6000B	Description: Lined Wellington Boots Unlined Wellington Boots	Colour: Black Black	Packing: 1pr/polybag 10prs/carton 1pr/polybag 10prs/carton



6000W
6000W-L

6000B
6000B-L



7000Y

7000B

Wellington Boots 7000B/ 7000Y

Similar to Series 6000 wellington boots but roomier fit around foot, ankle and leg. Easy to put on & pull off.

- Made of injection PVC.
- Fully lined.
- Height: 350mm to 380mm
- Size: 4 – 11



Product Code:	Description:	Colour:	Packing:
7000B	Lined Wellington Boots	Black/Brown	1pr/polybag 10prs/carton
7000Y	Lined Wellington Boots	Yellow/Black	1pr/polybag 10prs/carton



ES-318L

Derby Safety Shoe ES-318L

Lace up derby shoe with padded collar.



- Size: 4 – 11

Product Code:	Description:	Packing:
ES-318L	Safety Boots	1pr/box 15prs/carton



Derby Safety Shoe ES-308L-MS

Lace up derby shoe with padded collar.



- Size: 4 – 11

Product Code:	Description:	Packing:
ES-308L-MS	Safety Boots with steel midsole	1pr/box 15prs/carton



ES-338L

Slip-on Safety Shoe ES-338L

Slip-on shoe with padded collar.



- Size: 4 – 11

Product Code:	Description:	Packing:
ES-338L	Slip-on Safety Boots	1pr/box 15prs/carton



ES-328A

Lace-up Ankle Safety Shoe ES-328A

Ankle cut shoe with padded collar.



• Size: 4 – 11

Product Code:	Description:	Packing:
ES-328A	Ankle-cut Safety Boots	1pr/box 15prs/carton



ES-368R-BR

ES-368R-BLK

Rigger Safety Shoe ES-368R-BR/ ES-368R-BLK

Slip-on shoe with padded collar.



• Size: 5 – 11

Product Code:	Description:	Colour:	Packing:
ES-368R-BR	Rigger Safety Boots	Brown	1pr/box 10prs/carton
ES-368R-BLK	Rigger Safety Boots	Black	1pr/box 10prs/carton



ES-378R-BR-SMS

ES-378R-BLK-SMS

Rigger Safety Shoe ES-378R-BR-SMS/ ES-378R-BLK-SMS

Slip-on shoe with padded collar.



• Size: 5 – 11

Product Code:	Description:	Colour:	Packing:
ES-378R-BR-SMS	Rigger Safety Boots with steel midsole	Brown	1pr/box 10prs/carton
ES-378R-BLK-SMS	Rigger Safety Boots with steel midsole	Black	1pr/box 10prs/carton

Derby Safety Shoe ES-608L-MS

Lace up derby shoe with padded collar.



• Size: 4 – 11

Product Code:	Description:	Packing:
ES-608L-MS	Safety Boots with steel midsole	1pr/box 15prs/carton



ES-608L-MS



ES-618L

Derby Safety Shoe ES-618L

Lace up derby shoe with padded collar.



• Size: 4 – 11

Product Code:	Description:	Packing:
ES-618L	Safety Boots	1pr/box 15prs/carton



ES-638L

Slip-on Safety Shoe ES-638L

Slip-on shoe with padded collar.



• Size: 4 – 11

Product Code:	Description:	Packing:
ES-638L	Slip-on Safety Boots	1pr/box 15prs/carton



ES-628A

Lace-up Ankle Safety Shoe ES-628A

Ankle cut shoe with padded collar.



• Size: 4 – 11

Product Code:	Description:	Packing:
ES-628A	Ankle-cut Safety Boots	1pr/box 15prs/carton



ES-648Z

Zip-up Safety Shoe ES-648Z

Safety Boot with zipper.



• Size: 5 – 11

Product Code:	Description:	Packing:
ES-648Z	Rigger Safety Boots	1pr/box 10prs/carton



ES-298S

Lady Slip-on Safety Shoe ES-298S

Slip-on shoe with padded collar.



• Size: 3 – 8

Product Code:	Description:	Packing:
ES-298S	Lady Slip-on Safety Boots	1pr/box 15prs/carton



B-108

Protective Safety Shoe with Composite Toe Cap

B-108

Lace up derby shoe with padded collar.



• Size: 4 – 11

Product Code: B-108	Description: Safety Boots	Packing: 1pr/box 15prs/carton
------------------------	------------------------------	----------------------------------

Rigger Safety Shoe ES-668R-BR/ ES-668R-BLK

Slip-on shoe with padded collar.



• Size: 5 – 11

Product Code: ES-668R-BR ES-668R-BLK	Description: Rigger Safety Boots Rigger Safety Boots	Colour: Brown Black	Packing: 1pr/box 10prs/carton 1pr/box 10prs/carton
--	--	---------------------------	--



ES-668R-BLK

ES-668R-BR

Rigger Safety Shoe ES-678R-BR-SMS/ ES-678R-BLK-SMS

Slip-on shoe with padded collar.



• Size: 5 – 11

Product Code: ES-678R-BR-SMS	Description: Rigger Safety Boots with steel midsole	Colour: Brown	Packing: 1pr/box 10prs/carton
ES-678R-BLK-SMS	Rigger Safety Boots with steel midsole	Black	1pr/box 10prs/carton



ES-678R-BR-SMS

ES-678R-BLK-SMS



ES-618L-W

Derby Safety Shoe ES-618L-W

Lace up derby shoe with padded collar.



• Size: 4 – 11

Product Code: ES-618L-W	Description: White Safety Boots	Packing: 1pr/box 15prs/carton
----------------------------	------------------------------------	----------------------------------

Lace-up Ankle Safety Shoe ES-628A-W

Ankle cut shoe with padded collar.



• Size: 4 – 11

Product Code: ES-628A-W	Description: Ankle-cut White Safety Boots	Packing: 1pr/box 15prs/carton
----------------------------	--	----------------------------------



ES-628A-W



EUS 868

Executive Uniform Shoe EUS 863/ 868

- Genuine soft cow leather.
- Fully lined.
- Rubber Sole.
- Size: 4 – 11

Product Code: EUS 863 EUS 868	Description: Lace-up Executive Uniform Shoe Slip-on Executive Uniform Shoe	Packing: 1pr/box 20prs/carton 1pr/box 20prs/carton
-------------------------------------	--	--



EUS 863



Oil Resistant



Resistant



Energy
Absorption



Steel
Toe Cap



Reinforced
Side Stitching



Penetration
Resistant
Steel Midsole



Chemical
Resistant



Heat
Insulation

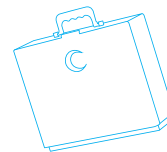

MS-S



MS-M



MS-L

First-Aid Kit MS-S/ MS-M/ MS-L

A necessity for any home, office, shops or factory outlets. Our compartmental organiser first-aid kit provide all your first aid needs including dressing, medications, antiseptics, bandages and instruments with everything you need to protect you in the event of a minor accident.

Product Code:	Description:	Packing:
MS-S	First-Aid Kit-Small	1set/pkt 10sets/carton
MS-M	First-Aid Kit-Medium	1set/pkt 10sets/carton
MS-L	First-Aid Kit-Large	1set/pkt 10sets/carton

Model: MS-S

Content:	Qty
1 • Acriflavine Solution 30ml	1
2 • Liniment Methyl Salicylate 30ml	1
3 • Antiseptic Cream 15gm	1
4 • Antiseptic Lotion 50ml	1
5 • Absorbent Cotton Wool (w/box) 5gm	1
6 • Gauze Swabs (w/box) 8pcs	1
7 • W.O.W Bandage 5cm x 5.5cm	1
8 • Medicated Oil 3ml	1
9 • Plaster Strips-Fabric	10
10 • Paracetamol Tablets (Axcel)	10
11 • Alcohol Swabs	2
12 • Adhesive Plaster-Roll	1
13 • Scissor Foldable-Small	1
14 • Tweezer	1
15 • First Aid Book	1
16 • Usage Card	1

Model: MS-M

Content:	Qty
1 • Acriflavine Solution 30ml	1
2 • Liniment Methyl Salicylate 30ml	1
3 • Antiseptic Cream 15gm	1
4 • Antiseptic Lotion 50ml	1
5 • Absorbent Cotton Wool (w/box) 5gm	1
6 • Gauze Swabs (w/box) 8pcs	1
7 • W.O.W Bandage 5cm x 5.5cm	1
8 • Medicated Oil 3ml	1
9 • Plaster Strips-Fabric	10
10 • Paracetamol Tablets (Axcel)	10
11 • Alcohol Swabs	2
12 • Adhesive Plaster-Roll	1
13 • Scissor Foldable-Small	1
14 • Tweezer	1
15 • First Aid Book	1
16 • Usage Card	1

Model: MS-L

Content:	Qty
1 • Acriflavine Solution 30ml	1
2 • Liniment Methyl Salicylate 30ml	1
3 • Antiseptic Cream 15gm	1
4 • Antiseptic Lotion 50ml	1
5 • Gauze Swabs (w/box) 8pcs	1
6 • W.O.W Bandage 2.5cm x 5.5cm	1
7 • W.O.W Bandage 5cm x 5.5cm	1
8 • W.O.W Bandage 7.5cm x 5.5cm	1
9 • Medicated Oil 3ml	1
10 • Plaster Strips-Fabric	10
11 • Paracetamol Tablets (Axcel)	20
12 • Alcohol Swabs	2
13 • Scissor Foldable-Small	1
14 • Tweezer	1
15 • Poh Chai Pills (Stomach Ache)	10
16 • Wooden Splint 45 155 4mm	1
17 • Cotton Buds	1
18 • Surgical Tape 1.25cm x 9.1m	1
19 • Triangular Bandage 915 x 915 1300m	1
20 • Gastric Tablets	1
21 • Cotton Wool	1
22 • Ultracarbons	10
23 • First Aid Book	1
24 • Usage Card	1

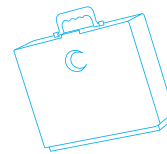

MS-LRF



MS-SRF



MS-MRF

First-Aid Kit Refills MS-SRF/ MS-MRF/ MS-LRF

Inspect & refill your first-aid kits regularly. This is a job everyone hates to do, so they put it aside. But if you want to stay within the safety regulations, check your first-aid kits periodically.

Product Code:	Description:	Packing:
MS-SRF	First-Aid Refill-Small	1set/pkt 10set/carton
MS-MRF	First-Aid Refill-Medium	1set/pkt 10set/carton
MS-LRF	First-Aid Refill-Large	1set/pkt 10set/carton



CP-FP

Bandages TP-PP/ CP-FP

An adhesive bandage is usually covered by woven fabric, plastic, or latex rubber which has an adhesive. Adhesive tapes used for wound care often have an absorbent pad (often medicated with antiseptic). The bandage is applied such that the pad covers the wound, and the fabric or plastic sticks to the surrounding skin to hold the dressing in place and prevent dirt from entering the wound.

Product Code:	Description:	Packing:
TP-PP	Plastic Bandage	100pcs/box/50box/carton
CP-FP	Fabric Bandage	100pcs/box/50box/carton



TP-PP

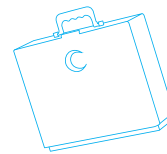

ML-238-L (Box A)



ML-238-LRF



ML-288-J (Box B)



ML-288-JRF



ML-298-G (Box C)



ML-298-GRF

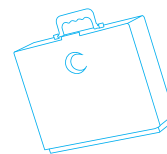

OSHA First Aid Kits ML-238-L/ ML-288-J/ ML-298-G

Reliable, economical work site first aid kit. The perfect solution to help you stay in compliance with OSHA regulations for first aid in the workplace. 3 types of First aid kit which allow you to choose the suitable size that fits your needs. All kits are packed in a durable, well marked metal box that can be mounted on the wall.

Product Code:	Description:	Packing:
ML-238-L	OSHA First Aid Kit - Large Suitable for 20 person	1 set 10sets/carton
ML-288-J	OSHA First Aid Kit - Jumbo Suitable for 50 person	1 set 10sets/carton
ML-298-G	OSHA First Aid Kit - Giant Suitable for 100 person	1 set 5sets/carton

OSHA First Aid Kits Refill

ML-238-LRF/ ML-288-JRF/ ML-298-GRF

OSHA compliance refill sets. Inspect & refill your OSHA first aid kit regularly. To stay within the safety regulation, check your OSHA first aid kits periodically.

Product Code:	Description:	Packing:
ML-238-LRF	OSHA First Aid Refill - Large Suitable for 20 person	1 set 10sets/carton
ML-288-JRF	OSHA First Aid Refill - Jumbo Suitable for 50 person	1 set 10sets/carton
ML-298-GRF	OSHA First Aid Refill - Giant Suitable for 100 person	1 set 5sets/carton

OSHA CONTENT		PROGUARD CONTENT	BOX A ML 238	BOX B ML 288	BOX C ML 298
1a		ML 238, METAL LARGE SIZE: 284 x 90 x 230MM (H)	1	-	-
1b		ML 288, METAL JUMBO SIZE: 382 x 105 x 270MM (H)	-	1	-
1c		MG 29, METAL GIANT SIZE: 513 x 130 x 396MM (H)	-	-	1
2	SMALL INDIVIDUAL MEDICATED OR UNMEDICATED STERILISED DRESSINGS, FOR FINGERS	STERILE MEDIUM ADHESIVE DRESSING 7.2CM X 5CM	6	12	24
3	MEDIUM SIZE INDIVIDUAL MEDICATED OR UNMEDICATED STERILISED DRESSINGS, FOR HANDS AND FEETS	STERILE LARGE ADHESIVE DRESSING 8.3CM X 6CM	3	6	12
4	LARGE INDIVIDUAL MEDICATED OR UNMEDICATED STERILISED DRESSINGS, FOR OTHER INJURED PARTS	STERILE EX-LARGE ADHESIVE DRESSING 10CM X 8CM	3	6	12
5	ASSORTED ADHESIVE WOUND DRESSINGS	ASSORTED ADHESIVE WOUND DRESSINGS 40'S	1	1	1
6	TRIANGULAR BANDAGE	TRIANGULAR BANDAGE	2	4	8
7	ROLLER BANDAGES, 1 INCH	W.O.W BANDAGE, 2.5CM X 5.5M	6	9	12
8	ROLLER BANDAGES, 2 INCH	W.O.W BANDAGE, 5.0CM X 5.5M	6	9	12
9	ADHESIVE PLASTER	SURGICAL TAPE WITH DISPENSER 1.25CM X 9.1M	1	2	3
10	ABSORBENT STERILISED COTTON WOOL IN 1/2 OZ. PACKETS OF COTTON-WOOL DISPENSER	COTTON WOOL 50GM	6	6	6
11	SUITABLE SPLINTS AND WOOL OR OTHER MATERIAL FOR PADDING	WOODEN SPLINT	2	4	8
12	APPROVED EYE OINTMENT OR EYE DROPS	EYE DROP 5ML	2	4	8
13	INDIVIDUAL STERILISED EYE PADS IN SEPARATE SEALED PACKETS	STERILISE EYE PAD	2	4	8
14	RUBBER OR PRESSURE BANDAGE	TOURNIQUET	1	1	1
15	A TWO PER CENT ALCOHOLIC SOLUTION OF IODINE, OR A ONE PER CENT AQUEOUS SOLUTION OF GENTIAN VIOLET IN A STOPPERED 2 OZ. BOTTLE	ACRIFLAVINE SOLUTION 30ML	6	6	6
16	A BOTTLE OF SAL VOLATILE WITH THE DOSE AND MODE OF ADMINISTRATION INDICATED ON THE LABEL	LINIMENT METHYL SALICYLATE 30ML	2	2	2
17	BLUNT-NOSED SURGICAL SCISSORS	SCISSOR N/FOLDABLE STAINLESS STEEL BLADE	1	1	1
18	SAFETY PINS	SAFETY PINS 12'S	1	2	3
TOTAL ITEMS INCLUDING BOX			18	18	18

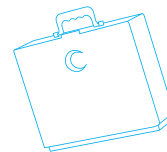

Stretcher FPS-S/ FPS-D

Safely move sick or injury patients. Lightweight with foldable design. These foldable pole stretchers built with aluminium poles and vinyl-coated nylon fabric won't add much weight when transferring patient. Rugged aluminium feet elevate patient with non-slip hand grips.

Product Code:	Description:	Packing:
FPS-S	Single Foldable Pole Stretcher	1 unit
FPS-D	Double Foldable Pole Stretcher	1 unit/bag



LSB-S / M / L / XL

Lifting Support Belt LSB-S / M / L / XL

Available in four size to fit major majority of your work force. Helps to reduce lower back discomfort & repetitive back strain.

- Wide, comfortable elastic suspenders for firm support, while retaining its elasticity for comfortable mobility.
- Smooth glide adjustable clips.
- Fully encloses spring-steel stay for additional stability to the lower back.
- Velcro closure for easy on/off.

Product Code:	Description:	Packing:
LSB-S	Lifting Support Belt-Small	1set/box 24sets/carton
LSB-M	Lifting Support Belt-Medium	1set/box 24sets/carton
LSB-L	Lifting Support Belt-Large	1set/box 24sets/carton
LSB-XL	Lifting Support Belt-Extra Large	1set/box 24sets/carton

Emergency Gravity-Feed Eyewash EPE-34/15

Self contained emergency gravity-feed eyewash hold water fluid in a tank where no plumbing required. After each use, tanks can be refilled. Gravity-feed units are ideal for sites where plumbed water supply is unavailable.

- In upright position, tray securely shut off water flow and keeps nozzles free of airborne contaminations.
- Wide rear opening allows easy filling, inspection and cleaning.
- The eyewash is activated by simply pulling the retractable tray.
- Polyethylene tank store 34 liters of water with the estimate flow rate of 1.75 liter per minute for 15minutes.
- Mounted on bracket supplied that easily bolts to wall.



EPE-34/15



EEB-H

Emergency Eyewash Bottle EEB-H

For immediate emergency flushing of eye injuries, this eyewash bottle provides fast, effective relief.

- Unbreakable, easy to squeeze polyethylene bottle has an eyecup with a captive snap-on cap.
- The eyecup has a perforated plate to break up the stream for a gentle spray to the eye.
- A capped air-vent valve prevents drawback of contaminated fluid back into bottle. Used water exits through a drain tube.

Product Code:	Description:	Capacity:	Packing
EPE-34/15	Emergency Gravity-Feed Eyewash	34 liters	1unit/carton
EEB-H	Emergency Eyewash Bottle	500ml	1unit/box 10unit/carton

EMERGENCY EYEWASH & SHOWERS

PROGUARD SAFETY PRODUCTS CATALOGUE

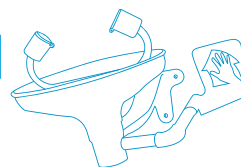

PG 5050



PG 5050 SS

Wall Mount Eyewash PG 5050/ PG 5050 SS

Where space may be a constraint, **PROGUARD** wall-mount eyewash fits easily into your workplace. Eyewash works quickly with a simple push of its highly visible handle.

PROGUARD eyewash sprayheads use the soft-flow aerators and automatic pressure compensating valve .

Standard Fixtures:

Eyewash Bowl: a) 280mm (11") bowl is injection moulded in chemical resistant ABS in bright yellow colour.
b) 280mm (11") bowl in high polished stainless steel.

Sprayhead Assembly: Chrome-plated brass with ABS sprayheads assembly with twin, soft-flow eyewash heads and instant flip-open protective dust-cover. The built in automatic pressure compensating valve assures safe steady flow under varying water supply conditions. Sprayheads also include a filter to protect users against particles from the water flow which may be damaging to the eyes & face.

Control Valve: Stainless steel 1/2" IPS valve that stays open until manually closed. Control valve is operated by a large, highly visible stainless steel push-plate.

Pipe and Fittings: 1/2" sch.10 stainless steel pipe epoxy powder coated to bright yellow colour.

Wall Bracket: Aluminium wall-mounting bracket epoxy powder coated to bright yellow with 3 mounting holes.

Waste: 1 1/4" IPS tail piece.

Signage: Eyewash.

Compliance: ANSI Z358.1-2004

Pipe Threads: Standard pipe threads in accordance to BS 21 or DIN 259 are supplied. ANSI B2.1 pipe threads are also available on request.

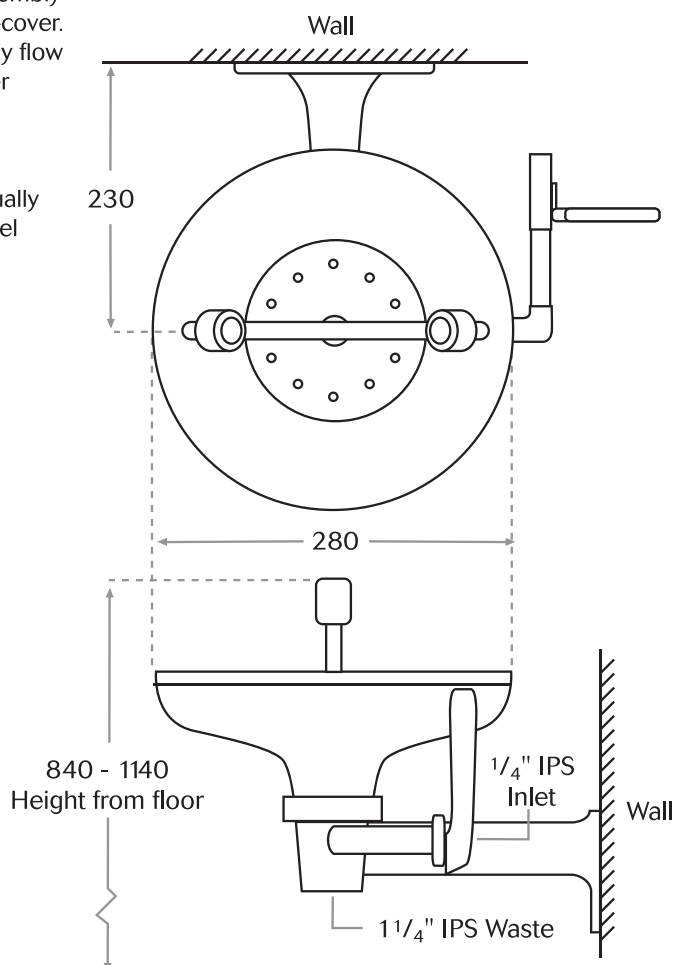

Product Code:	Description:	Packing:
PG 5050	Eyewash with ABS bowl	1 unit/ctn
PG 5050 SS	Eyewash with Stainless Steel bowl	1 unit/ctn
PG 5115	Eyewash with ABS bowl & Foot Pedal	1 unit/ctn
PG 5115 SS	Eyewash with Stainless Steel bowl & Foot Pedal	1 unit/ctn

EMERGENCY EYEWASH & SHOWERS

PROGUARD SAFETY PRODUCTS CATALOGUE

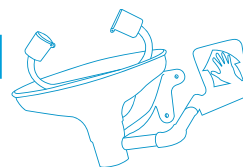

PG 5060



PG 5060 SS



PG 5070



PG 5070 SS

Pedestal Mounted Eyewash PG 5060/ PG 5060 SS/ PG 5070/ PG 5070 SS

These fine units work very well in any environment. This unit can be mounted onto a floor and operated either by hand or by foot.

PROGUARD eyewash sprayheads use the soft-flow aerators and automatic pressure compensating valve.

Standard Fixtures:

Eyewash Bowl:

- a) 280mm (11") bowl is injection moulded in chemical resistant ABS bright yellow colour.
- b) 280mm (11") bowl in high polished stainless steel.

Sprayhead Assembly: Chrome-plated brass with ABS sprayheads assembly with twin, soft-flow eyewash heads and instant flip-open protective dust-cover. The built in automatic pressure compensating valve assures safe steady flow under varying water supply conditions. Sprayheads also include a filter to protect users against particles from the water flow which may be damaging to the eyes & face.

Control Valve: Stainless steel 1/2" IPS valve that stays open until manually closed. Control valve is operated by a large, highly visible stainless steel push-plate.

Pedestal: Sand-cast iron 250mm (10") pedestal with 3 mounting holes for 9mm bolts.

Pipe and Fittings: 1/2" and 1 1/4" sch.10 stainless steel pipe epoxy powder coated to bright yellow colour.

Waste: 1 1/4" IPS tail piece.

Water Supply: 1/2" IPS

Signage: Eyewash.

Compliance: ANSI Z358.1-2004

Pipe Threads: Standard pipe threads in accordance to BS 21 or DIN 259 are supplied. ANSI B2.1 pipe threads are also available on request.

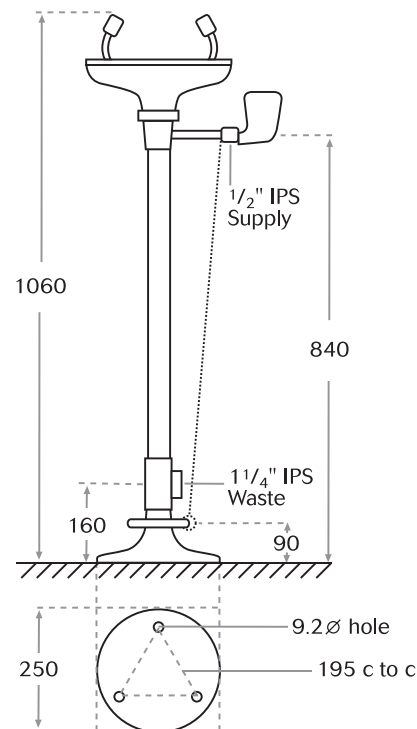

Product Code:	Description:	Packing:
PG 5060	ABS bowl Emergency Eyewash	1 unit/ctn
PG 5060 SS	S/Steel bowl Emergency Eyewash	1 unit/ctn
PG 5070	ABS bowl Emergency Eyewash with foot pedal	1 unit/ctn
PG 5070 SS	S/Steel bowl Emergency Eyewash with foot pedal	1 unit/ctn

EMERGENCY EYEWASH & SHOWERS

PROGUARD SAFETY PRODUCTS CATALOGUE

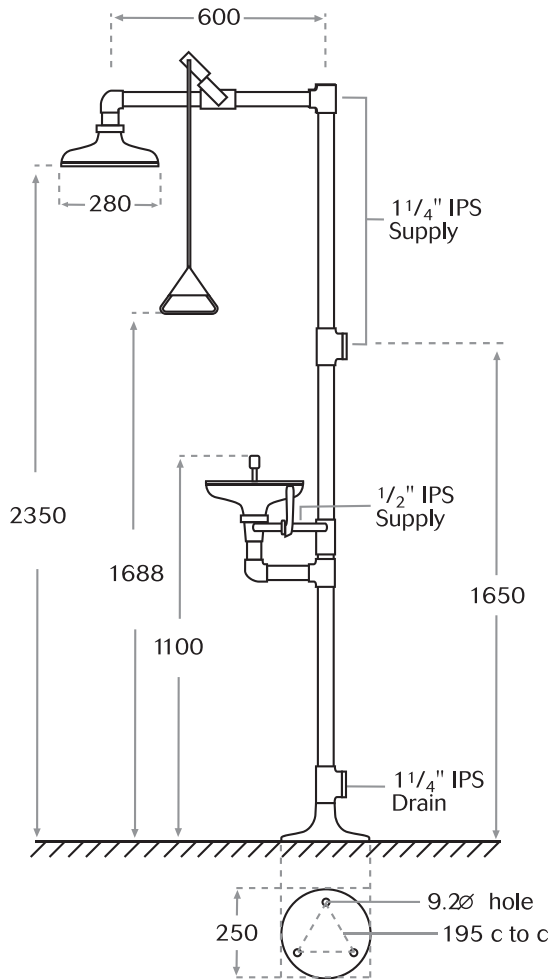
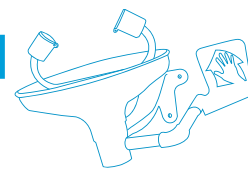

Floor Mount Combination Unit of Drench Shower and Eyewash with Plastic Bowl

PG 10020AB/ PG 10022AB

Our combination unit of drench and eyewash is popular in workplace where fire and chemical spillages may occur. All control valves are the instant action, stay opened type of ball valve. This unit comes with or without foot pedal.

Standard Fixtures:

Shower and Eyewash Bowl: 280mm (11") injection moulded of corrosion resistant ABS plastic in bright yellow colour.

Eyewash Sprayhead Assembly: Chrome plated brass with ABS sprayheads assembly with double soft-flow eyewash heads and instant flip-open protective dust cover. The built in automatic compensating valve assures safe steady flow under varying water supply conditions. Sprayheads also include a filter to protect users against particles from the water flow which may be damaging to the eyes & face.

Control Valves: 1" fast-action stainless steel ball valve is used for the shower head stainless pull rod. 1/2" fast-action stainless steel ball valve is used for the eyewash assembly with stainless steel push plate.

Pedestal: 250mm (10") sand cast iron pedestal with 3 mounting holes for 9mm bolts. Pedestal is powder coated in yellow.

Pipe and Fittings: 1 1/4" stainless steel schedule 10 pipes fully coated in corrosion resistant epoxy powder in yellow colour.

Waste: 1 1/4" IPS

Water Supply: 1 1/4" IPS

Signage: Drench shower and Eyewash

Compliance: ANSI Z358.1-2004

Pipe Threads: Standard pipe threads in accordance to BS 21 or DIN 259 are supplied. ANSI B2.1 pipe threads are also available on request.

Product Code:	Description:	Packing:
PG 10020AB	ASB bowl Combination Emergency Shower & Eyewash	1 unit/ctn
PG 10022AB	ASB bowl Combination Emergency Shower & Eyewash with foot pedal	1 unit/ctn

EMERGENCY EYEWASH & SHOWERS

PROGUARD SAFETY PRODUCTS CATALOGUE

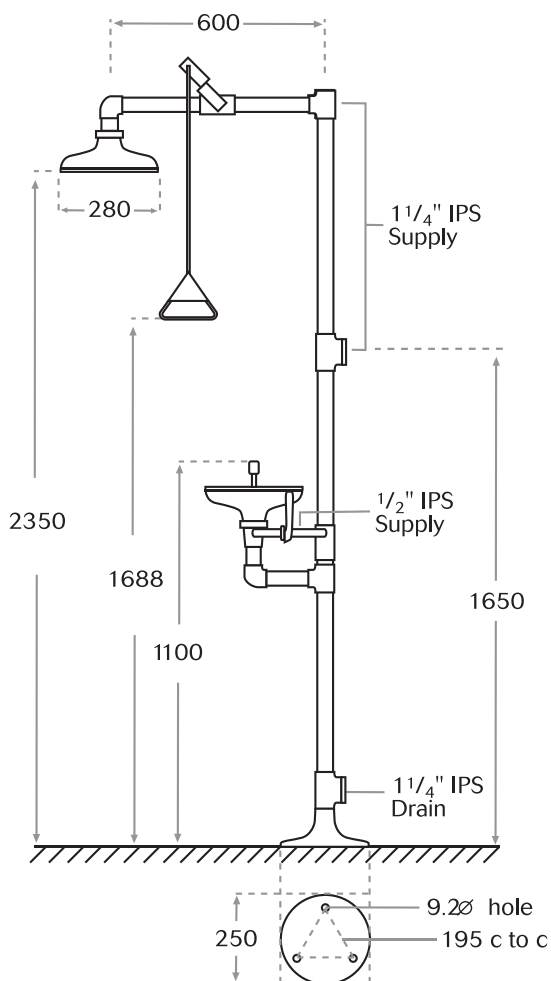
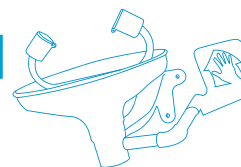

Floor Mount Combination Unit of Drench Shower and Eyewash with Stainless Steel Bowl PG 10022SS/ PG 10020SS

Our combination unit of drench and eyewash is popular in workplace where fire and chemical spillages may occur. All control valves are the instant action, stay open type of ball valve. This unit comes with or without foot pedal.

Standard Fixtures:

Shower and Eyewash Bowl: 280mm (11") bowl in high polished stainless steel.

Eyewash Sprayhead Assembly: Chrome plated brass with ABS sprayheads assembly with double soft-flow eyewash heads and instant flip-open protective dust cover. The built in automatic compensating valve assures safe steady flow under varying water supply conditions. Sprayheads also include a filter to protect users against particles from the water flow which may be damaging to the eyes & face.

Control Valves: 1" fast-action stainless steel ball valve is used for the shower head stainless pull rod. 1/2" fast-action stainless steel ball valve is used for the eyewash assembly with stainless steel push plate.

Pedestal: 250mm (10") sand cast iron pedestal with 3 mounting holes for 9mm bolts. Pedestal is powder coated in yellow.

Pipe and Fittings: 1 1/4" stainless steel schedule 10 pipes fully coated in corrosion resistant epoxy powder in yellow colour.

Waste: 1 1/4" IPS

Water Supply: 1 1/4" IPS

Signage: Drench shower and Eyewash

Compliance: ANSI Z358.1-2004

Pipe Threads: Standard pipe threads in accordance to BS 21 or DIN 259 are supplied. ANSI B2.1 pipe threads are also available on request.

Product Code:	Description:	Packing:
PG 10020SS	S/Steel bowl Combination Emergency Shower & Eyewash	1 unit/ctn
PG 10022SS	S/Steel bowl Combination Emergency Shower & Eyewash with foot pedal	1 unit/ctn

EMERGENCY EYEWASH & SHOWERS

PROGUARD SAFETY PRODUCTS CATALOGUE

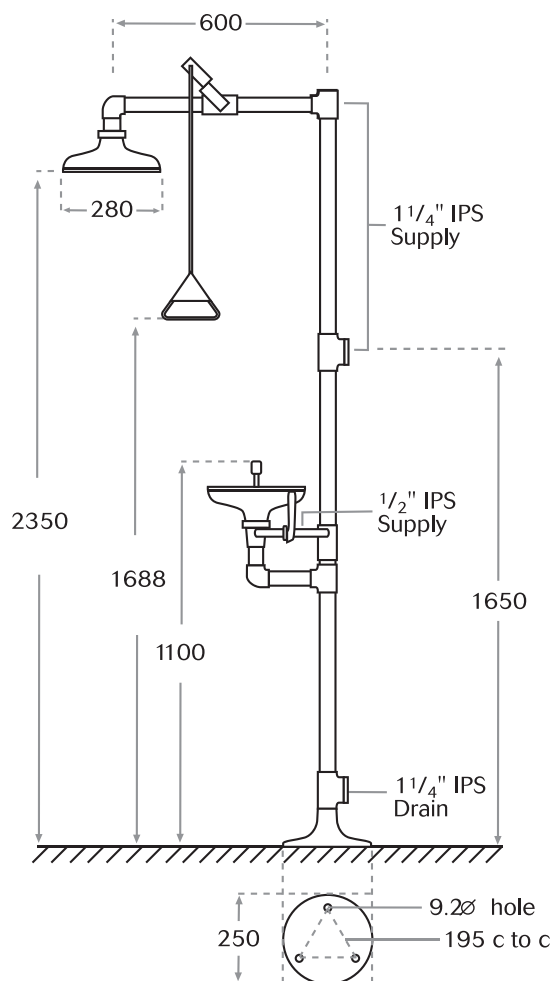
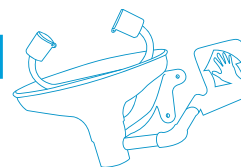

PG 10001

PG 10000

Floor Mount Combination Unit of ABS Drench Shower and Stainless Steel Eyewash Bowl

PG 10001 / PG 10000

Our combination unit of drench and eyewash is popular in workplace where fire and chemical spillages may occur. All control valves are the instant action, stay open type of ball valve. This unit comes with or without foot pedal.

Standard Fixtures:

Shower Bowl: 280mm (11") injection moulded of corrosion resistant ABS plastic in bright yellow colour.

Eyewash Bowl: 280mm (11") bowl in high polished stainless steel.

Eyewash Sprayhead Assembly: Chrome plated brass with ABS sprayheads assembly with double soft-flow eyewash heads and instant flip-open protective dust cover. The built in automatic compensating valve assures safe steady flow under varying water supply conditions. Sprayheads also include a filter to protect users against particles from the water flow which may be damaging to the eyes & face.

Control Valves: 1" fast-action stainless steel ball valve is used for the shower head stainless pull rod. 1/2" fast-action stainless steel ball valve is used for the eyewash assembly with stainless steel push plate.

Pedestal: 250mm (10") sand cast iron pedestal with 3 mounting holes for 9mm bolts. Pedestal is powder coated in yellow.

Pipe and Fittings: 1 1/4" stainless steel schedule 10 pipes fully coated in corrosion resistant epoxy powder in yellow colour.

Waste: 1 1/4" IPS

Water Supply: 1 1/4" IPS

Signage: Drench shower and Eyewash

Compliance: ANSI Z358.1-2004

Pipe Threads: Standard pipe threads in accordance to BS 21 or DIN 259 are supplied. ANSI B2.1 pipe threads are also available on request.

Product Code:	Description:	Packing:
PG 10001	Combination unit of ABS Drench Shower & S/Steel Eyewash bowl with foot pedal	1 unit/ctn
PG 10000	Combination unit of ABS Drench Shower & S/Steel Eyewash bowl	1 unit/ctn

EMERGENCY EYEWASH & SHOWERS

PROGUARD SAFETY PRODUCTS CATALOGUE

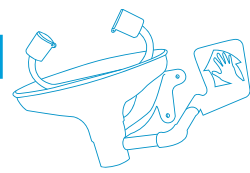

IM 90-136



S 09-200



IM 50-777



S 05-123

IM 55-CD



O 25-059



S 18-223



IM 26-166D



S 128-2U

Product Code:	Description:	Packing:	Product Code:	Description:	Packing:
IM 90-136	ABS Plastic Shower bowl	1 unit/ctn	S 128-2U	Stainless Steel Pull Rod	1 unit/ctn
IM 50-777	ABS Plastic Eyewash bowl	1 unit/ctn	S 18-223	Stainless Steel Push Handle	1 unit/ctn
S 09-200	Stainless Steel Shower bowl	1 unit/ctn	IM 55-CD	Eyewash Head Assembly	1 unit/ctn
S 05-123	Stainless Steel Eyewash bowl	1 unit/ctn	IM 26-166D	Foot Pedal with Stainless Steel Chain	1 unit/ctn
O 25-059	1" Control Valve with lever	1 unit/ctn			

SAFETY CANS

PROGUARD SAFETY PRODUCTS CATALOGUE



Safety Storage Cans Type I & II

Keeping flammable liquids safe and easy to handle is a very serious issue. Safety Cans are the perfect solution for storing, pouring and disposing of flammable liquids with maximum safety. These cans are specially designed to automatically relieve the build-up of internal pressure, preventing explosion and personal injury. The only way an ordinary metal can with a screw on cap can relieve vapor pressure is by EXPLODING! However, with our metal cans the pressure is relieved safely and automatically. They even retain a major portion of its contents after the fire.

Type I - These cans have a single spout for both pouring and filling.

Type II - These cans have separate openings for filling and for pouring.

The pouring is done with a flexible metal spout.



Type I - Safety Cans



Reliable Double Torsion Spring-

The most important first line of defense in preventing an explosion or flash-back into the gas can during fire exposure. Automatically relieves internal pressure - preventing can explosion. These cans are the only cans on the market that comply with ANSI/UL 30 and FM testing standards.



Powder Coat Finish-

This finish is applied as dry, finely ground particles of pigment and resin, then sticks to the can as a continuous film when melted and fused creating both a decorative and protective surface. The result is a smooth, durable and high-quality finish.

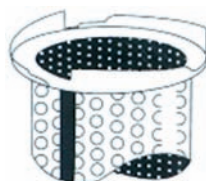

Full Flow Flash Arrestor-

Protects flammable contents from external sparks or flames. Full flow design allows for faster filling at the gas pump and prevents annoying nozzle click off. Quarter-turn cam locking ring meets the requirements to be replaceable and secure in place.

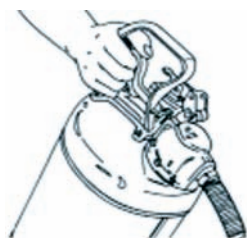

Type II containers incorporate all of Type I design features plus:

Vapor Control Flexible Nozzle -

Directs the flow to control spilling and the escape of toxic vapors. A brass tip prevents sparking or static build up.



Type II - Safety Cans

Product Code:	Capacity:	Weight (Lbs.):
Type I		
T1-10 SC1000	1 Gallon	4 Liters 5
T1-20 SC1020	2 Gallons	7 Liters 6
T1-25 SC1025	2½ Gallons	9 Liters 8
Type II		
T2-20 SC2020	2 Gallons	7 Liters 9
T2-25 SC2025	2½ Gallons	9 Liters 10

SAFETY CANS & CABINETS

PROGUARD SAFETY PRODUCTS CATALOGUE

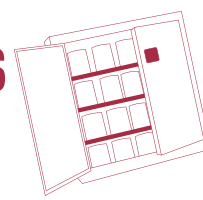

Corrosive & Acid Storage Cabinets

Keep all acids safe and at hand with Flammable/Corrosive Storage Cabinets for both flammable and non-flammable corrosives. Comply with NFPA and current OSHA requirements. Cabinets finished in blue corrosive-resistant urethane.

All cabinets comply with **current OSHA regulations** and are designed in accordance with the standards of **NFPA Code 30. FM approved.**



Product Code:	Capacity:	Dimension (HxWxD-in):	Doors:	# of shelves:	Weight (lbs.):
C124	24gal	36x 35 x 22	2 manual	1	207
C224	24gal	36x 35 x 22	2 self closing	1	212
C130	30gal	44 x 43 x 18	2 manual	1	270
C230	30gal	44 x 43 x 18	1 sliding	1	275
C330	30gal	46 x 43 x 18	2 self closing	1	290
C145	45gal	65 x 43 x 18	2 manual	2	363
C245	45gal	65 x 43 x 18	1 sliding	2	368
C345	45gal	67 x 43 x 18	2 self closing	2	383
C160	60gal	65 x 31 x 31	2 manual	2	396
C260	60gal	65 x 34 x 34	1 sliding	2	401
C360	60gal	67 x 31 x 31	2 self closing	2	418

Safety Can Storage Cabinets

Keep **Flammable Liquids** close to the work area in a safe and organized way while limiting employee exposure with **Safety Storage Cabinet**.

Cabinets are designed to meet safety requirements for the handling of **Flammable Liquids**. Choose from a large selection of models from 4 to 90 gallon storage capacity. Smaller compact cabinets are convenient where space is limited.

All cabinets comply with **current OSHA regulations** and are designed in accordance with the standards of **NFPA Code 30. FM approved.**



Product Code:	Capacity:	Dimension (HxWxD-in):	Doors:	# of shelves:	Weight (lbs.):
A130	30gal	44 x 43 x 18	2 manual	1	247
A230	30gal	44 x 43 x 18	1 sliding	1	252
A330	30gal	44 x 43 x 18	2 self closing	1	267
A145	45gal	65 x 43 x 18	2 manual	2	220
A245	45gal	65 x 43 x 18	1 sliding	2	223
A345	45gal	67 x 43 x 18	2 self closing	2	235
A160	60gal	65 x 31 x 31	2 manual	2	372
A260	60gal	65 x 34 x 34	1 sliding	2	377
A360	60gal	67 x 31 x 31	2 self closing	2	394
A190	90gal	65 x 43 x 31	2 manual	2	443
A290	90gal	65 x 43 x 31	1 sliding	2	448
A390	90gal	67 x 43 x 31	2 self closing	2	473

SAFETY CANS & CABINETS

PROGUARD SAFETY PRODUCTS CATALOGUE

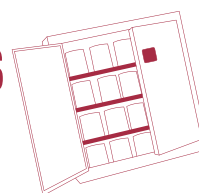

Paint & Ink Storage Cabinets

Safety storage cabinets for 1-gallon paint cans are available in 20, 40, 60 and up to 120-gallon capacities. Warning label reads "Flammable - Keep Fire Away". Perfect for print shops or auto body repair. Available in manual, sliding, and self-closing door models.

All cabinets comply with **current OSHA regulations** and are designed in accordance with the standards of **NFPA Code 30. FM approved**.

Product Code:	Capacity:	Dimension (HxWxD-in):	Doors:	# of shelves:	Weight (lbs.):
P120	20gal	44 x 24 x 18	1 manual	2	169
P320	20gal	46 x 24 x 18	1 self closing	2	179
P140	40gal	44 x 43 x 18	2 manual	3	271
P340	40gal	46 x 43 x 18	2 self closing	3	291
P160	60gal	65 x 43 x 18	2 manual	5	373
P360	60gal	67 x 43 x 18	2 self closing	5	393
P1120	120gal	65 x 31 x 31	2 manual	5	414
P3120	120gal	67 x 31 x 31	2 self closing	5	436



Corrosive & Acid Storage Cabinets

Keep all acids safe with **PROGUARD®** Flammable/Corrosive Storage Cabinets for both flammable and nonflammable corrosives. Finished in blue corrosive-resistant paint.

Features:

- Double wall thermal barrier with 30mm air buffer camber.
- Inlet & outlet jacket can be totally seal.
- Adjustable shelves-enforced to support 90kgs load.
- Manual door/s with open close function latch with locks.
- Stainless Steel Door Hinges.
- Prominent hazard label at door.
- Baked epoxy powder finish.
- Levelling screw at foot.
- Cabinet with built-in earth cable.
- Dual vent built-in with a 50mm suction neck option for suction system.



Product Code:	Capacity:	Dimension (HxWxD-mm):	Doors:	# of shelves:	Weight (kgs.):
UL-ACLC75	75 liter	1100 x 600 x 450	1 manual	2	80
UL-ACLC115	115 liter	1100 x 850 x 450	2 manual	2	100
UL-ACLC180	180 liter	700 x 1050 x 875	2 manual	1	120
UL-ACLC230	230 liter	1650 x 1090 x 450	2 manual	3	150

Safety Storage Cabinets

Keep Flammable Liquids close to the work area in a safe and organized way with **PROGUARD®** Safety Storage Cabinet. Designed to meet safety requirements for handling of Flammable Liquids.

Features:

- Double wall thermal barrier with 30mm insulating air barrier.
- Inlet & outlet jacket can be totally seal.
- Adjustable shelves-enforced to support 90kgs load.
- Manual door/s with open close function latch with locks.
- Stainless Steel Door Hinges.
- Prominent hazard label at door.
- Baked epoxy powder finish.
- Levelling screw at foot.
- Cabinet with built-in earth cable.
- Dual vent built-in with a 50mm suction neck option for suction system.



Product Code:	Capacity:	Dimension (HxWxD-mm):	Doors:	# of shelves:	Weight (kgs.):
UL-FPC75	75 liter	1100 x 600 x 450	1 manual	2	80
UL-FPC115	115 liter	1100 x 850 x 450	2 manual	2	100
UL-FPC180	180 liter	700 x 1050 x 875	2 manual	1	120
UL-FPC230	230 liter	1650 x 1090 x 450	2 manual	3	150

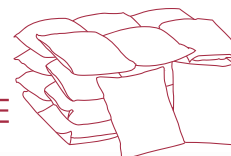

Oil Only Laminate Sorbent Pad

BOS-LMT2002/ BOS-LMT4002

These laminate oil pads are with dimple & perforated and made from meltblown polypropylene fine fibers, increase of tensile strength for durability as these laminate sorbent pads can be re-useable many times. Fast absorbing for use with oil or petroleum base fluid containment only. Suitable for clearing up oil spill in ocean, river or lake, shipping terminal, crude storage, workshops & etc.



BOS-LMT2002
BOS-LMT4002

Product Code:	Size:	Thickness:	Quantity:	Absorbency:	Type:
BOS-LMT2002	41cm x 51cm	3mm	200pcs/carton	>145liter/carton	single weight
BOS-LMT4002	41cm x 51cm	8mm	100pcs/carton	>145liter/carton	double weight

Oil Only Sorbent Sock BOS-SOC7612/ BOS-SOC7636



BOS-SOC7612
BOS-SOC7636

Dependable & flexible socks that contain and absorb liquid oils. Will assist companies to comply with the Health and Safety Act by contributing cleaner & safer working environments. These oil sorbent socks are effectively absorb oil leaks around machinery as it can mold around machinery corners or uneven surface to prevent spill & drips. It is also a daily maintenance tools for many industries including chemical plants, heavy & light manufacturing, transportation, printing & etc.

Product Code:	Size:	Quantity:	Absorbency:
BOS-SOC7612	Ø 7.6cm x 1.2 M	12pcs/carton	>100liter/carton
BOS-SOC7636	Ø 7.6cm x 3.6 M	4pcs/carton	>100liter/carton

Oil Only Sorbent Pillow BOS-PIL2025/ BOS-PIL4050

Sorbent pillows meet variety of cleanup and safety needs. Oil sorbent pillows are useful for absorbing oil in confined areas such as sumps, fluid reservation, bilges and tanks. These oil sorbent pillows are excellent for absorbing oil spills and leaking fluids in tight spaces.



BOS-PIL2025
BOS-PIL4050

Product Code:	Size:	Quantity:	Absorbency:
BOS-PIL2025	20cm x 25cm	32pcs/carton	> 90liter/carton
BOS-PIL4050	40cm x 50cm	16pcs/carton	>144liter/carton



BOS-FLD3802S

Oil Only Sorbent Folded BOS-FLD3802S

These oil sorbent folded are made from laminated oil sorbent pads with dimple & perforated and made from meltblown polypropylene fine fibers, increase of tensile strength for durability as these laminate oil sorbent pads can be re-useable many times. Fast absorbing for use with oil or petroleum base fluid containment only. Sorbent-Folded can be used as booms, pillows, pads, or rolls - making sorbents the most versatile spill response products available on the market today.

Product Code:	Size:	Quantity:	Absorbency:
BOS-FLD3802S	38cm X 15m	1 roll/carton	>32liter/carton

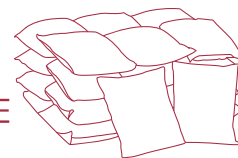

Universal Sorbent Pad MOS-LMT2002/ MOS-LMT4002

These versatile universal sorbents pads can be used for acids and non-aggressive spills like oil, coolant, water & solvent on open space surface. These universal sorbent pads are with dimple & perforated & made from meltblown polypropylene fine fibers, increase of tensile strength for durability as these sorbent pads can be re-useable many times. Its can be used for cover and scatter or pave the spill oil or chemical on floor.



MOS-LMT2002
MOS-LMT4002

Product Code:	Size:	Thickness:	Quantity:	Absorbency:	Type:
MOS-LMT2002	41cm x 51cm	3mm	200pcs/carton	>145liter/carton	single weight
MOS-LMT4002	41cm x 51cm	8mm	100pcs/carton	>145liter/carton	double weight

Universal Sorbent Sock MOS-SOC7612/ MOS-SOC7636

Cellulosic sorbent contained with a flexible polypropylene skin for the purpose of containing & absorbing oils, coolants, solvents, water and other non-aggressive liquids that leak or drip from machinery. Absorbent socks are used primarily in everyday house-keeping around machinery that's leak, seep & spill coolant or oils. They fit snugly against the machine bases and wrap around corners, keeping the work area safe & dry.



MOS-SOC7612
MOS-SOC7636

Product Code:	Size:	Quantity:	Absorbency:
MOS-SOC7612	Ø 7.6cm x 1.2 M	12pcs/carton	>100liter/carton
MOS-SOC7636	Ø 7.6cm x 3.6 M	4pcs/carton	>100liter/carton

Universal Sorbent Pillow MOS-PIL2025/ MOS-PIL4050

Sorbent pillows meet variety of cleanup and safety needs. These universal sorbent pillows are useful for absorbing oil coolants, solvents, water and other non-aggressive liquids that leak or drip from machinery. These oil sorbent pillows are fast absorb and easy to deploy.



MOS-PIL2025
MOS-PIL4050

Product Code:	Size:	Quantity:	Absorbency:
MOS-PIL2025	20cm x 25cm	32pcs/carton	> 90liter/carton
MOS-PIL4050	40cm x 50cm	16pcs/carton	>144liter/carton

Universal Sorbent Folded MOS-FLD3802S

These universal sorbent folded are made from universal sorbent pads with dimple & perforated and made from meltblown polypropylene fine fibers, increase of tensile strength for durability as these universal sorbent-Folded used to absorb acids, non-aggressive spills like oil, coolant, water & solvent and can be used as booms, pillows, pads, or rolls - making sorbents the most versatile spill response products available on the market today.



MOS-FLD3802S

Product Code:	Size:	Quantity:	Absorbency:
MOS-FLD3802S	38cmX15m	1 roll/carton	>32liter/carton

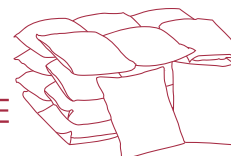

Chemical Sorbent Pad HOS-LMT2002/ HOS-LMT4002

These chemical sorbents pads can be used for aggressive & non-aggressive chemical such as acids and caustic liquids. These chemical sorbent pads are with dimple & perforated and made from meltblown polypropylene fine fibers, increase of tensile strength for durability as these sorbent pads can be re-useable many times. Ideal for laboratory spills and transportation hazardous material spill response.



HOS-LMT2002
HOS-LMT4002

Product Code:	Size:	Thickness:	Quantity:	Absorbency:	Type:
HOS-LMT2002	41cm x 51cm	3mm	200pcs/carton	>145liter/carton	single weight
HOS-LMT4002	41cm x 51cm	8mm	100pcs/carton	>145liter/carton	double weight



HOS-SOC7612
HOS-SOC7636

Chemical Sorbent Sock HOS-SOC7612/ HOS-SOC7636

Cellulosic sorbent contained with a flexible polypropylene skin for the purpose of containing & absorbing petroleum-based fluids, aggressive & non-aggressive chemicals and aqueous-based solutions, reducing the need to stock several different sorbent types for emergency response.

Product Code:	Size:	Quantity:	Absorbency:
HOS-SOC7612	Ø 7.6cm x 1.2 M	12pcs/carton	>100liter/carton
HOS-SOC7636	Ø 7.6cm x 3.6 M	4pcs/carton	>100liter/carton

Chemical Sorbent Pillow HOS-PIL2025/ HOS-PIL4050

Chemical sorbent pillows meet variety of cleanup and safety needs. These chemical sorbent pillows are useful for absorbing petroleum-based fluids, aggressive & non-aggressive chemicals and aqueous-based solutions, reducing the need to stock several different sorbent types for emergency response. These universal sorbent pillows are fast absorb and easy to deploy.



HOS-PIL2025
HOS-PIL4050

Product Code:	Size:	Quantity:	Absorbency:
HOS-PIL2025	20cm x 25cm	32pcs/carton	> 90liter/carton
HOS-PIL4050	40cm x 50cm	16pcs/carton	>144liter/carton



HOS-FLD3802S

Chemical Sorbent Folded HOS-FLD3802S

These chemical sorbent folded are made from chemical sorbent pads with dimple & perforated and made from meltblown polypropylene fine fibers, increase of tensile strength for durability as these sorbent pads can be re-useable many times. Chemical Sorbent-Folded used to absorbs acids, non-aggressive spills like oil, coolant, water & solvent and can be used as booms, pillows, pads, or rolls - making sorbents the most versatile spill response products available on the market today.

Product Code:	Size:	Quantity:	Absorbency:
HOS-FLD3802S	38cm X 15m	1 roll/carton	>32liter/carton

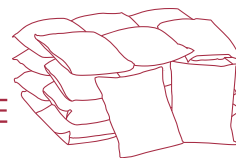

240 liter Dispenser Cart Spill Kit - Oil Only SK683838

These dispenser cart spill kits offers maximum oil & petroleum absorption at a great price no matter on land or water. Hydrophobic polypropylene (repel water) for reliable oil and petroleum absorption. Absorption capability up to 230 liters.

Contents:

- 1 pc – 240 liter Transporter
- 4pcs – Oil-only Sorbent Sock BOS-SOC7636 (1pc-able to absorb > 25 liters)
- 8pcs – Oil-only Sorbent Pillow BOS-PIL4050 (1pc-able to absorb > 9 liters)
- 40pcs – Oil-only Sorbent Pads BOS-LMT4002 (1pc-able to absorb > 1.4 liters)
- 10pcs – Hazardous material disposable bag 24" x 30"
- 10pcs – Cable Tie
- 2 pcs – Disposable coverall
- 2 prs – Anti-Fog goggle
- 2 prs – Nitrile Glove



SK683838

SK293939



240 liter Portable Spill Kit - Universal Only SK293939

These Universal dispenser cart spill kits are applicable for multipurpose usage. Universal sorbents are best for absorbing chemical spills, leaks & drips. Solvents, coolants or even stronger acids and caustics can be readily absorbed with these sorbents. Absorption capability up to 230 liters.

Contents:

- 1 pc – 240 liter Transporter
- 4pcs – Universal Sorbent Sock MOS-SOC7636 (1pc-able to absorb > 25 liters)
- 8pcs – Universal Sorbent Pillow MOS-PIL4050 (1pc-able to absorb > 9 liters)
- 40pcs – Universal Sorbent Pads MOS-LMT4002 (1pc-able to absorb > 1.4 liters)
- 10pcs – Hazardous material disposable bag 42" x 52"
- 10pcs – Cable Tie
- 2 pcs – Disposable coverall
- 2 prs – Anti-Fog goggle
- 2 prs – Nitrile Glove



SK573737

240 liter Portable Spill Kit - Chemical Only SK573737

These dispenser spill kits designed for quick response to containing all types of aggressive acids & caustics liquid drips, leaks and spills before migration occurs. Absorption capability up to 230 liters.

Contents:

- 1 pc – 240 liter Transporter
- 4pcs – Chemical Sorbent Sock HOS-SOC7636 (1pc-able to absorb > 25 liters)
- 8pcs – Chemical Sorbent Pillow HOS-PIL4050 (1pc-able to absorb > 9 liters)
- 40pcs – Chemical Sorbent Pads HOS-LMT4002 (1pc-able to absorb > 1.4 liters)
- 10pcs – Hazardous material disposable bag 42" x 52"

- 10pcs – Cable Tie
- 2 pcs – Disposable coverall
- 2 prs – Anti-Fog goggle
- 2 prs – Nitrile Glove



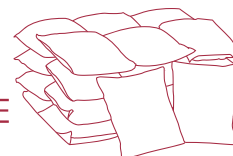

120 liter Dispenser Cart Spill Kit - Oil Only SK682828

Whether on land or water, these dispenser cart spill kits offers maximum oil & petroleum absorption at a great price. Hydrophobic polypropylene (repel water) for reliable oil and petroleum absorption. Can absorb up to total 115 liters.

Contents:

- 1 pc – 120 liter Transporter
- 2pcs – Oil-only Sorbent Sock BOS-SOC7636 (1pc-able to absorb > 25 liters)
- 4pcs – Oil-only Sorbent Pillow BOS-PIL4050 (1pc-able to absorb > 9 liters)
- 20pcs – Oil-only Sorbent Pads BOS-LMT4002 (1pc-able to absorb > 1.4 liters)
- 10pcs – Hazardous material disposable bag 24" x 30"
- 10pcs – Cable Tie
- 2 pcs – Disposable coverall
- 2 prs – Anti-Fog goggle
- 2 prs – Nitrile Glove



SK682828

SK292929



120 liter Portable Spill Kit - Universal Only SK292929

SK292929

These dispenser cart universal spill kits are applicable to many uses. Universal sorbents are best for absorbing chemical spills, leaks & drips. Solvents, coolants and even stronger acids and caustics can be readily picked up with these sorbents. Can absorb up to total 115 liters.

Contents:

- 1 pc – 120 liter Transporter
- 2pcs – Universal Sorbent Sock MOS-SOC7636 (1pc-able to absorb > 25 liters)
- 4pcs – Universal Sorbent Pillow MOS-PIL4050 (1pc-able to absorb > 9 liters)
- 20pcs – Universal Sorbent Pads MOS-LMT4002 (1pc-able to absorb > 1.4 liters)
- 10pcs – Hazardous material disposable bag 24" x 30"
- 10pcs – Cable Tie
- 2 pcs – Disposable coverall
- 2 prs – Anti-Fog goggle
- 2 prs – Nitrile Glove

120 liter Portable Spill Kit - Chemical Only SK572727

SK572727

These dispenser spill kits designed for quick response to containing all types of aggressive acids & caustics liquid drips, leaks and spills before migration occurs. Can absorb up to total 115 liters.

Contents:

- 1 pc – 120 liter Transporter
- 2pcs – Chemical Sorbent Sock HOS-SOC7636 (1pc-able to absorb > 25 liters)
- 4pcs – Chemical Sorbent Pillow HOS-PIL4050 (1pc-able to absorb > 9 liters)
- 20pcs – Chemical Sorbent Pads HOS-LMT4002 (1pc-able to absorb > 1.4 liters)
- 10pcs – Hazardous material disposable bag 24" x 30"

- 10pcs – Cable Tie
- 2 pcs – Disposable coverall
- 2 prs – Anti-Fog goggle
- 2 prs – Nitrile Glove



SK572727

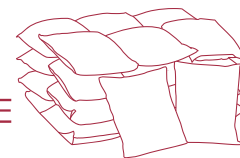

18 liter Portable Spill Kit - Oil Only SK681818

Whether on land or water, these portable spill kits offers maximum oil & petroleum absorption at a great price. Hydrophobic polypropylene (repel water) for reliable oil and petroleum absorption. Can absorb up to total 25 liters.

Contents:

- 1 pc – 18liter Pail
- 2pcs – Oil-only Sorbent Sock BOS-SOC7612 (1pc-able to absorb > 8.25 liters)
- 2pcs – Oil-only Sorbent Pillow BOS-PIL2025 (1pc-able to absorb > 2.5 liters)
- 5pcs – Oil-only Sorbent Pads BOS-LMT2002 (1pc-able to absorb > 0.7 liters)
- 2pcs – Hazardous material disposable bag 24" x 30"
- 2pcs – Cable Tie
- 1 pr – Anti-Fog goggle
- 1 pr – Nitrile Glove



SK681818

18 liter Portable Spill Kit - Universal Only SK291919

These universal spill kits are applicable to many uses. Universal sorbents are best for absorbing chemical spills, leaks & drips. Solvents, coolants and even stronger acids and caustics can be readily picked up with these sorbents. Can absorb up to total 25 liters.

Contents:

- 1 pc – 18liter Pail
- 2pcs – Universal Sorbent Sock MOS-SOC7612 (1pc-able to absorb > 8.25 liters)
- 2pcs – Universal Sorbent Pillow MOS-PIL2025 (1pc-able to absorb > 2.5 liters)
- 5pcs – Universal Sorbent Pads MOS-LMT2002 (1pc-able to absorb > 0.7 liters)
- 2pcs – Hazardous material disposable bag 24" x 30"
- 2pcs – Cable Tie
- 1 pr – Anti-Fog goggle
- 1 pr – Nitrile Glove



SK291919

SK571717



18 liter Portable Spill Kit - Chemical Only SK571717

These portable spill kits designed for quick response to containing all types of aggressive acids & caustics liquid drips, leaks and spills before migration occurs. Can absorb up to total 25 liters.

Contents:

- 1 pc – 18liter Pail
- 2pcs – Chemical Sorbent Sock HOS-SOC7612 (1pc-able to absorb > 8.25 liters)
- 2pcs – Chemical Sorbent Pillow HOS-PIL2025 (1pc-able to absorb > 2.5 liters)
- 5pcs – Chemical Sorbent Pads HOS-LMT-2002 (1pc-able to absorb > 0.7 liters)
- 2pcs – Hazardous material disposable bag 24" x 30"
- 2pcs – Cable Tie
- 1 pr – Anti-Fog goggle
- 1 pr – Nitrile Glove

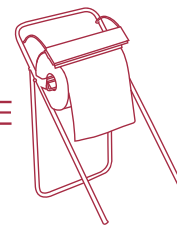

HMDB2430/ HMDB4252

Hazardous Material Disposal Bags HMDB2430/ HMDB4252

Hold saturated cleanup materials for safe, proper disposal. Each opaque, bright yellow bag is identified with large, bold, continuous message, "HAZARDOUS MATERIAL, HANDLE WITH CARE". Super strong construction.

Product Code:	Description:	Thickness:	Packing:
HMDB2430	24" x 30" Disposal Bag	0.10mm	24pcs/bag
HMDB4252	42" x 52" Disposal Bag	0.12mm	24pcs/bag



JRT600



JRT1000

Tissue Roll Wipers JRT600/ JRT1000

Suitable for areas whereby a continuous supply of a single-use wiper is required. Ideal replacement for cotton rags. Reduce wastage with more drying efficiency & wiping performance over rags.

Product Code:	Size:	Packing:
JRT600	31cm (W) x 600m (L)	2roll/carton
JRT1000	26cm (W) x 1000m (L)	2roll/carton

Tissue Roll Stand - Dispenser JRT-Stand

Floor mounted stand for industrial roll tissue. A mobile & efficient dispenser.

Product Code:	Size:	Packing:
JRT-Stand	16.75"x33"x18.5" Dispenser	1pc



JRT-Stand



WB15130C/ WB10150BR

Welding Blanket WB15130C/ WB10150BR

Welding blankets protect your projects equipments or machinery from abrasions, molten metal, slag, sparks, spatter and extreme temperatures.

Product Code:	Description:	Packing:
WB15130C	1.5mm(T) x 1m(W) x 30m(L) Welding Blanket (White)	1roll
WB10150BR	1.0mm(T) x 1m(W) x 50m(L) Welding Blanket (Brown)	1roll

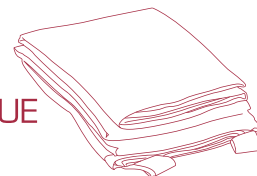

TL-281

Fireman's Axe TL-281

Forged heat treated, steel heads. Polished pick and blade, blue trim. Clear finish and fiberglass handles with rubber grip insulation. Precision balanced for fast cutting and safer handling.

Product Code:	Description:	Packing:
TL-281	3-1/2 lb Fireman Axe	1 pc



FB44CD



FB46CD

Fire Blanket FB44CD/ FB46CD

These fire blankets quickly smother flames to minimize burn injuries or prevent a fire from spreading. Coated & treated with additional fire retardant. Durable PVC bag protects the blanket from dust and safely breaks away during an emergency.

Product Code:	Description:	Packing:
FB44CD	4ft x 4ft Fire Blanket	1unit/bag 10unit/carton
FB46CD	4ft x 6ft Fire Blanket	1unit/bag 10unit/carton

Replacement Wind Sock RWS-24R/ 32R/ 36R

Indicate and responders to potential dangerous wind changes and help to avoid exposure to strong windblown.

Product Code:	Description:	Packing:
RWS-24R	24" Dia x 6' Replacement Wind Sock	1pc/pkt
RWS-32R	32" Dia x 6' Replacement Wind Sock	1pc/pkt
RWS-36R	36" Dia x 6' Replacement Wind Sock	1pc/pkt



RWS-24R/ 32R/ 36R

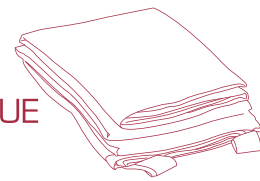

Glove Holder GH-3800/ 3810/ 3820/ 3830/ 3840/ 3850

GH-3800/ 3810/ 3820/ 3830/ 3840/ 3850

These indispensable accessories promote worker safety by preventing glove loss. Clips snugly to body via belt, tool pouch or any pocket. Made of non-conductive plastic with no spring or metal parts to rust or corrode. Keep gloves & other items close at hand – ready to use when or where they are needed, therefore improving hand safety & comply with safety programs.

Product Code:	Description:	Packing:
GH-3800	Glove Holder-Red	100pcs/carton
GH-3810	Glove Holder-Orange	100pcs/carton
GH-3820	Glove Holder-Yellow	100pcs/carton
GH-3830	Glove Holder-Green	100pcs/carton
GH-3840	Glove Holder-Blue	100pcs/carton
GH-3850	Glove Holder-Black	100pcs/carton



Utility Holder UH-9800/ 9810/ 9820/ 9830/ 9840/ 9850

UH-9800/ 9810/ 9820/ 9830/ 9840/ 9850

These utility holders are multi-purpose clip that can be used in conjunction with many other items at the same time. It can be use to hold welding helmets, safety helmets, face shields, earmuffs, key rings, handsaw, measuring tape & etc.

Product Code:	Description:	Packing:
UH-9800	Utility Holder-Red	100pcs/carton
UH-9810	Utility Holder-Orange	100pcs/carton
UH-9820	Utility Holder-Yellow	100pcs/carton
UH-9830	Utility Holder-Green	100pcs/carton
UH-9840	Utility Holder-Blue	100pcs/carton
UH-9850	Utility Holder-Black	100pcs/carton



Mandatory Signs

Definition of a Mandatory Signs.

- These signs display a specific behavior message or action that must be carried out within a designated area.



Product Code:	Type:	Width x Height (mm):
MS 1680	Rigid Plastic Sheet	300 x 400
MS 2680	Self-adhesive Labels	300 x 400
MS 1680L	Rigid Plastic Sheet	400 x 600
MS 2680L	Self-adhesive Labels	400 x 600



Product Code:	Type:	Width x Height (mm):
MS 1681	Rigid Plastic Sheet	300 x 400
MS 2681	Self-adhesive Labels	300 x 400
MS 1681L	Rigid Plastic Sheet	400 x 600
MS 2681L	Self-adhesive Labels	400 x 600



Product Code:	Type:	Width x Height (mm):
MS 1682	Rigid Plastic Sheet	300 x 400
MS 2682	Self-adhesive Labels	300 x 400
MS 1682L	Rigid Plastic Sheet	400 x 600
MS 2682L	Self-adhesive Labels	400 x 600



Product Code:	Type:	Width x Height (mm):
MS 1683	Rigid Plastic Sheet	300 x 400
MS 2683	Self-adhesive Labels	300 x 400
MS 1683L	Rigid Plastic Sheet	400 x 600
MS 2683L	Self-adhesive Labels	400 x 600



Product Code:	Type:	Width x Height (mm):
MS 1684	Rigid Plastic Sheet	300 x 400
MS 2684	Self-adhesive Labels	300 x 400
MS 1684L	Rigid Plastic Sheet	400 x 600
MS 2684L	Self-adhesive Labels	400 x 600



Product Code:	Type:	Width x Height (mm):
MS 1685	Rigid Plastic Sheet	300 x 400
MS 2685	Self-adhesive Labels	300 x 400
MS 1685L	Rigid Plastic Sheet	400 x 600
MS 2685L	Self-adhesive Labels	400 x 600



Product Code:	Type:	Width x Height (mm):
MS 1686	Rigid Plastic Sheet	300 x 400
MS 2686	Self-adhesive Labels	300 x 400
MS 1686L	Rigid Plastic Sheet	400 x 600
MS 2686L	Self-adhesive Labels	400 x 600



Product Code:	Type:	Width x Height (mm):
MS 1687	Rigid Plastic Sheet	300 x 400
MS 2687	Self-adhesive Labels	300 x 400
MS 1687L	Rigid Plastic Sheet	400 x 600
MS 2687L	Self-adhesive Labels	400 x 600



Product Code:	Type:	Width x Height (mm):
MS 1688	Rigid Plastic Sheet	300 x 400
MS 2688	Self-adhesive Labels	300 x 400
MS 1688L	Rigid Plastic Sheet	400 x 600
MS 2688L	Self-adhesive Labels	400 x 600



Product Code:	Type:	Width x Height (mm):
MS 1689	Rigid Plastic Sheet	300 x 400
MS 2689	Self-adhesive Labels	300 x 400
MS 1689L	Rigid Plastic Sheet	400 x 600
MS 2689L	Self-adhesive Labels	400 x 600



Product Code:	Type:	Width x Height (mm):
MS 1690	Rigid Plastic Sheet	300 x 400
MS 2690	Self-adhesive Labels	300 x 400
MS 1690L	Rigid Plastic Sheet	400 x 600
MS 2690L	Self-adhesive Labels	400 x 600



Product Code:	Type:	Width x Height (mm):
MS 1691	Rigid Plastic Sheet	300 x 400
MS 2691	Self-adhesive Labels	300 x 400
MS 1691L	Rigid Plastic Sheet	400 x 600
MS 2691L	Self-adhesive Labels	400 x 600



Product Code:	Type:	Width x Height (mm):
MS 1692	Rigid Plastic Sheet	300 x 400
MS 2692	Self-adhesive Labels	300 x 400
MS 1692L	Rigid Plastic Sheet	400 x 600
MS 2692L	Self-adhesive Labels	400 x 600

Product Code:	Type:	Width x Height (mm):
MS 1693	Rigid Plastic Sheet	300 x 400
MS 2693	Self-adhesive Labels	300 x 400
MS 1693L	Rigid Plastic Sheet	400 x 600
MS 2693L	Self-adhesive Labels	400 x 600

Product Code:	Type:	Width x Height (mm):
MS 1694	Rigid Plastic Sheet	300 x 400
MS 2694	Self-adhesive Labels	300 x 400
MS 1694L	Rigid Plastic Sheet	400 x 600
MS 2694L	Self-adhesive Labels	400 x 600



Product Code:	Type:	Width x Height (mm):
MD 1380	Rigid Plastic Sheet	300 x 100
MD 2380	Self-adhesive Labels	300 x 100

Product Code:	Type:	Width x Height (mm):
MD 1381	Rigid Plastic Sheet	300 x 100
MD 2381	Self-adhesive Labels	300 x 100

Product Code:	Type:	Width x Height (mm):
MD 1382	Rigid Plastic Sheet	300 x 100
MD 2382	Self-adhesive Labels	300 x 100



Product Code:	Type:	Width x Height (mm):
MD 1383	Rigid Plastic Sheet	300 x 100
MD 2383	Self-adhesive Labels	300 x 100

Product Code:	Type:	Width x Height (mm):
MD 1384	Rigid Plastic Sheet	300 x 100
MD 2384	Self-adhesive Labels	300 x 100

Product Code:	Type:	Width x Height (mm):
MD 1385	Rigid Plastic Sheet	300 x 100
MD 2385	Self-adhesive Labels	300 x 100



Product Code:	Type:	Width x Height (mm):
MD 1386	Rigid Plastic Sheet	300 x 100
MD 2386	Self-adhesive Labels	300 x 100

Product Code:	Type:	Width x Height (mm):
MD 1387	Rigid Plastic Sheet	300 x 100
MD 2387	Self-adhesive Labels	300 x 100

Product Code:	Type:	Width x Height (mm):
MD 1388	Rigid Plastic Sheet	300 x 100
MD 2388	Self-adhesive Labels	300 x 100

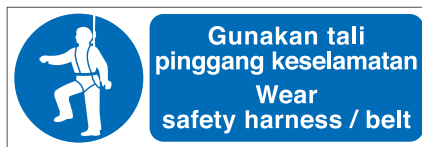

Product Code:	Type:	Width x Height (mm):
MD 1389	Rigid Plastic Sheet	300 x 100
MD 2389	Self-adhesive Labels	300 x 100

Product Code:	Type:	Width x Height (mm):
MD 1390	Rigid Plastic Sheet	300 x 100
MD 2390	Self-adhesive Labels	300 x 100

Product Code:	Type:	Width x Height (mm):
MD 1391	Rigid Plastic Sheet	300 x 100
MD 2391	Self-adhesive Labels	300 x 100



Product Code:	Type:	Width x Height (mm):
MD 1392	Rigid Plastic Sheet	300 x 100
MD 2392	Self-adhesive Labels	300 x 100

Product Code:	Type:	Width x Height (mm):
MD 1393	Rigid Plastic Sheet	300 x 100
MD 2393	Self-adhesive Labels	300 x 100

Product Code:	Type:	Width x Height (mm):
MD 1394	Rigid Plastic Sheet	300 x 100
MD 2394	Self-adhesive Labels	300 x 100



Gunakan topi keselamatan dan sepatu keselamatan di kawasan ini
Safety helmets and safety boots must be worn on this site

Product Code:	Type:	Width x Height (mm):
MS 1801	Rigid Plastic Sheet	600 x 400
MS 2801	Self-adhesive Labels	600 x 400

TAPAK KESELAMATAN SITE SAFETY

Di bawah Akta Keselamatan & Kesihatan 1994, setiap orang mesti mematuhi segala peraturan semasa berada di tapak pembinaan. Semua pelawat hendaklah melaporkan diri kepada pejabat pembinaan sebelum masuk di mana kawasan tapak pembinaan. Papan tanda keselamatan dan tatatertib mestilah dipatuhi dan alat-alat keselamatan mestilah digunakan sepanjang masa.

Under The Health & Safety at Work Act 1994, all persons entering this site must comply with all regulations under this act. All visitors must report to the site office and obtain permission to proceed on to the site or any work area. Safety sign and procedures must be observed and personal protective equipment must be used at all times.

Pembinaan sedang dijalankan.
Construction work in progress.

Gunakan topi & sepatu keselamatan.
Wear safety boots & helmets.

Di larang masuk tanpa kebenaran.
Unauthorised entry to this site is strictly forbidden.

Product Code:	Type:	Width x Height (mm):
MS 1802	Rigid Plastic Sheet	900 x 600
MS 2802	Self-adhesive Labels	900 x 600

Gunakan alat-alat keselamatan yang diluluskan
Wear approved personal protective equipment

Product Code:	Type:	Width x Height (mm):
MS 1803	Rigid Plastic Sheet	600 x 400
MS 2803	Self-adhesive Labels	600 x 400

Gunakan alat-alat keselamatan yang sesuai
Wear appropriate personal protective equipment

Product Code:	Type:	Width x Height (mm):
MS 1804	Rigid Plastic Sheet	600 x 400
MS 2804	Self-adhesive Labels	600 x 400

GUNAKAN ALAT-ALAT KESELAMATAN YANG SESUAI
WEAR APPROPRIATE PERSONAL PROTECTIVE EQUIPMENT

Gunakan topi keselamatan
Wear safety helmets

Gunakan sepatu keselamatan
Wear boots

Gunakan pelindung telinga
Wear ear protection

Gunakan pelindung mata
Wear eye protection

Product Code:	Type:	Width x Height (mm):
MS 1806	Rigid Plastic Sheet	1800 x 600
MS 2806	Self-adhesive Labels	1800 x 600

Semua pelawat mesti melaporkan diri di pondok pengawal
All visitor must report to the guardhouse

Product Code:	Type:	Width x Height (mm):
MS 1805	Rigid Plastic Sheet	600 x 400
MS 2805	Self-adhesive Labels	600 x 400

GUNAKAN ALAT-ALAT KESELAMATAN YANG SESUAI
WEAR APPROPRIATE PERSONAL PROTECTIVE EQUIPMENT

Gunakan baju pelindung keselamatan
Wear protective clothing

Gunakan pelitup gas
Wear respirator

Gunakan pelindung muka
Wear face shield

Gunakan sarung tangan
Wear glove

Product Code:	Type:	Width x Height (mm):
MS 1807	Rigid Plastic Sheet	1800 x 600
MS 2807	Self-adhesive Labels	1800 x 600



Can't see what you need? Custom made?

Call our customer service dept. for assistant or contact our nearest authorised distributor.

GUNAKAN ALAT-ALAT KESELAMATAN YANG SESUAI
WEAR APPROPRIATE PERSONAL PROTECTIVE EQUIPMENT

Gunakan topi keselamatan
Wear safety helmets

Gunakan sepatu keselamatan
Wear boots

Gunakan tali pinggang keselamatan
Wear safety harness / belt

Gunakan pelindung mata
Wear eye protection

Product Code:	Type:	Width x Height (mm):
MS 1808	Rigid Plastic Sheet	1800 x 600
MS 2808	Self-adhesive Labels	1800 x 600



GUNAKAN ALAT-ALAT KESELAMATAN YANG SESUAI
WEAR SUITABLE PROTECTIVE EQUIPMENT

- Gunakan topi keselamatan**
Wear safety helmets
- Gunakan sepatu keselamatan**
Wear boots
- Gunakan pelindung telinga**
Wear ear protection
- Gunakan pelindung mata**
Wear eye protection

GUNAKAN ALAT-ALAT KESELAMATAN YANG SESUAI
WEAR SUITABLE PROTECTIVE EQUIPMENT

- Gunakan baju pelindung keselamatan**
Wear protective clothing
- Gunakan pelutup gas**
Wear respirator
- Gunakan pelindung muka**
Wear face shield
- Gunakan sarung tangan**
Wear glove

GUNAKAN ALAT-ALAT KESELAMATAN YANG SESUAI
WEAR SUITABLE PROTECTIVE EQUIPMENT

- Gunakan topi keselamatan**
Wear safety helmets
- Gunakan sepatu keselamatan**
Wear boots
- Gunakan tali pinggang keselamatan**
Wear safety harness / belt
- Gunakan pelindung mata**
Wear eye protection

Product Code:	Type:	Width x Height (mm):
MS 1809	Rigid Plastic Sheet	300 x 400
MS 2809	Self-adhesive Labels	300 x 400
MS 1809L	Rigid Plastic Sheet	400 x 600
MS 2809L	Self-adhesive Labels	400 x 600

Product Code:	Type:	Width x Height (mm):
MS 1810	Rigid Plastic Sheet	300 x 400
MS 2810	Self-adhesive Labels	300 x 400
MS 1810L	Rigid Plastic Sheet	400 x 600
MS 2810L	Self-adhesive Labels	400 x 600

Product Code:	Type:	Width x Height (mm):
MS 1811	Rigid Plastic Sheet	300 x 400
MS 2811	Self-adhesive Labels	300 x 400
MS 1811L	Rigid Plastic Sheet	400 x 600
MS 2811L	Self-adhesive Labels	400 x 600

Warning Signs

Definition of a warning safety signs.

- Identify and warn visitors, staff and the public of possible dangers and hazards.

Bahan kimia berbahaya
Dangerous chemicals

Product Code:	Type:	Width x Height (mm):
WD 1401	Rigid Plastic Sheet	300 x 100
WD 2401	Self-adhesive Labels	300 x 100

AWAS
Mudah terbakar
CAUTION
Highly flammable

Product Code:	Type:	Width x Height (mm):
WD 1403	Rigid Plastic Sheet	300 x 100
WD 2403	Self-adhesive Labels	300 x 100

AWAS
Voltan tinggi
CAUTION
High voltage

Product Code:	Type:	Width x Height (mm):
WD 1404	Rigid Plastic Sheet	300 x 100
WD 2404	Self-adhesive Labels	300 x 100

AWAS
Permukaan licin
CAUTION
Slippery surface

Product Code:	Type:	Width x Height (mm):
WD 1405	Rigid Plastic Sheet	300 x 100
WD 2405	Self-adhesive Labels	300 x 100

AWAS
CAUTION

Product Code:	Type:	Width x Height (mm):
WD 1406	Rigid Plastic Sheet	300 x 100
WD 2406	Self-adhesive Labels	300 x 100

BAHAYA
DANGER

Product Code:	Type:	Width x Height (mm):
WD 1407	Rigid Plastic Sheet	300 x 100
WD 2407	Self-adhesive Labels	300 x 100

AWAS
Bahan merengsa
CAUTION
Harmful or irritant material

Product Code:	Type:	Width x Height (mm):
WD 1409	Rigid Plastic Sheet	300 x 100
WD 2409	Self-adhesive Labels	300 x 100

Corrosive

Product Code:	Type:	Width x Height (mm):
WD 1412	Rigid Plastic Sheet	300 x 100
WD 2412	Self-adhesive Labels	300 x 100

Biohazard
Bio Hazard

Product Code:	Type:	Width x Height (mm):
WD 1413	Rigid Plastic Sheet	300 x 100
WD 2413	Self-adhesive Labels	300 x 100

BAHAYA
Voltan tinggi
DANGER
High voltage

Product Code:	Type:	Width x Height (mm):
WD 1416	Rigid Plastic Sheet	300 x 100
WD 2416	Self-adhesive Labels	300 x 100

BAHAYA
Kawasan bunyi bising
DANGER
High noise area

Product Code:	Type:	Width x Height (mm):
WD 1419	Rigid Plastic Sheet	300 x 100
WD 2419	Self-adhesive Labels	300 x 100

BAHAYA
Permukaan panas jangan sentuh
DANGER
Hot surface do not touch

Product Code:	Type:	Width x Height (mm):
WD 1420	Rigid Plastic Sheet	300 x 100
WD 2420	Self-adhesive Labels	300 x 100

BAHAYA
Jaga kepala anda
DANGER
Mind your head

Product Code:	Type:	Width x Height (mm):
WD 1422	Rigid Plastic Sheet	300 x 100
WD 2422	Self-adhesive Labels	300 x 100

AWAS
Berhati-hati terhadap tangan dan jari anda
CAUTION
Be careful your hands and fingers

Product Code:	Type:	Width x Height (mm):
WD 1423	Rigid Plastic Sheet	300 x 100
WD 2423	Self-adhesive Labels	300 x 100

BAHAYA
Asid
DANGER
Acid

Product Code:	Type:	Width x Height (mm):
WD 1424	Rigid Plastic Sheet	300 x 100
WD 2424	Self-adhesive Labels	300 x 100



Product Code:	Type:	Width x Height (mm):
WS 1201	Rigid Plastic Sheet	300 x 400
WS 2201	Self-adhesive Labels	300 x 400
WS 1201L	Rigid Plastic Sheet	400 x 600
WS 2201L	Self-adhesive Labels	400 x 600



Product Code:	Type:	Width x Height (mm):
WS 1202	Rigid Plastic Sheet	300 x 400
WS 2202	Self-adhesive Labels	300 x 400
WS 1202L	Rigid Plastic Sheet	400 x 600
WS 2202L	Self-adhesive Labels	400 x 600



Product Code:	Type:	Width x Height (mm):
WS 1203	Rigid Plastic Sheet	300 x 400
WS 2203	Self-adhesive Labels	300 x 400
WS 1203L	Rigid Plastic Sheet	400 x 600
WS 2203L	Self-adhesive Labels	400 x 600



Product Code:	Type:	Width x Height (mm):
WS 1204	Rigid Plastic Sheet	300 x 400
WS 2204	Self-adhesive Labels	300 x 400
WS 1204L	Rigid Plastic Sheet	400 x 600
WS 2204L	Self-adhesive Labels	400 x 600



Product Code:	Type:	Width x Height (mm):
WS 1205	Rigid Plastic Sheet	300 x 400
WS 2205	Self-adhesive Labels	300 x 400
WS 1205L	Rigid Plastic Sheet	400 x 600
WS 2205L	Self-adhesive Labels	400 x 600



Product Code:	Type:	Width x Height (mm):
WS 1206	Rigid Plastic Sheet	300 x 400
WS 2206	Self-adhesive Labels	300 x 400
WS 1206L	Rigid Plastic Sheet	400 x 600
WS 2206L	Self-adhesive Labels	400 x 600



Product Code:	Type:	Width x Height (mm):
WS 1207	Rigid Plastic Sheet	300 x 400
WS 2207	Self-adhesive Labels	300 x 400
WS 1207L	Rigid Plastic Sheet	400 x 600
WS 2207L	Self-adhesive Labels	400 x 600



Product Code:	Type:	Width x Height (mm):
WS 1208	Rigid Plastic Sheet	300 x 400
WS 2208	Self-adhesive Labels	300 x 400
WS 1208L	Rigid Plastic Sheet	400 x 600
WS 2208L	Self-adhesive Labels	400 x 600



Product Code:	Type:	Width x Height (mm):
WS 1209	Rigid Plastic Sheet	300 x 400
WS 2209	Self-adhesive Labels	300 x 400
WS 1209L	Rigid Plastic Sheet	400 x 600
WS 2209L	Self-adhesive Labels	400 x 600



Product Code:	Type:	Width x Height (mm):
WS 1210	Rigid Plastic Sheet	300 x 400
WS 2210	Self-adhesive Labels	300 x 400
WS 1210L	Rigid Plastic Sheet	400 x 600
WS 2210L	Self-adhesive Labels	400 x 600



Product Code:	Type:	Width x Height (mm):
WS 1211	Rigid Plastic Sheet	300 x 400
WS 2211	Self-adhesive Labels	300 x 400
WS 1211L	Rigid Plastic Sheet	400 x 600
WS 2211L	Self-adhesive Labels	400 x 600



Product Code:	Type:	Width x Height (mm):
WS 1212	Rigid Plastic Sheet	300 x 400
WS 2212	Self-adhesive Labels	300 x 400
WS 1212L	Rigid Plastic Sheet	400 x 600
WS 2212L	Self-adhesive Labels	400 x 600



Product Code:	Type:	Width x Height (mm):
WS 1213	Rigid Plastic Sheet	300 x 400
WS 2213	Self-adhesive Labels	300 x 400
WS 1213L	Rigid Plastic Sheet	400 x 600
WS 2213L	Self-adhesive Labels	400 x 600



Product Code:	Type:	Width x Height (mm):
WS 1214	Rigid Plastic Sheet	300 x 400
WS 2214	Self-adhesive Labels	300 x 400
WS 1214L	Rigid Plastic Sheet	400 x 600
WS 2214L	Self-adhesive Labels	400 x 600



Product Code:	Type:	Width x Height (mm):
WS 1215	Rigid Plastic Sheet	300 x 400
WS 2215	Self-adhesive Labels	300 x 400
WS 1215L	Rigid Plastic Sheet	400 x 600
WS 2215L	Self-adhesive Labels	400 x 600



Product Code:	Type:	Width x Height (mm):
WS 1216	Rigid Plastic Sheet	300 x 400
WS 2216	Self-adhesive Labels	300 x 400
WS 1216L	Rigid Plastic Sheet	400 x 600
WS 2216L	Self-adhesive Labels	400 x 600



Product Code:	Type:	Width x Height (mm):
WS 1217	Rigid Plastic Sheet	300 x 400
WS 2217	Self-adhesive Labels	300 x 400
WS 1217L	Rigid Plastic Sheet	400 x 600
WS 2217L	Self-adhesive Labels	400 x 600



Product Code:	Type:	Width x Height (mm):
WS 1218	Rigid Plastic Sheet	300 x 400
WS 2218	Self-adhesive Labels	300 x 400
WS 1218L	Rigid Plastic Sheet	400 x 600
WS 2218L	Self-adhesive Labels	400 x 600



Product Code:	Type:	Width x Height (mm):
WS 1219	Rigid Plastic Sheet	300 x 400
WS 2219	Self-adhesive Labels	300 x 400
WS 1219L	Rigid Plastic Sheet	400 x 600
WS 2219L	Self-adhesive Labels	400 x 600



Product Code:	Type:	Width x Height (mm):
WS 1220	Rigid Plastic Sheet	300 x 400
WS 2220	Self-adhesive Labels	300 x 400
WS 1220L	Rigid Plastic Sheet	400 x 600
WS 2220L	Self-adhesive Labels	400 x 600



Product Code:	Type:	Width x Height (mm):
WS 1221	Rigid Plastic Sheet	300 x 400
WS 2221	Self-adhesive Labels	300 x 400
WS 1221L	Rigid Plastic Sheet	400 x 600
WS 2221L	Self-adhesive Labels	400 x 600



Product Code:	Type:	Width x Height (mm):
WS 1222	Rigid Plastic Sheet	300 x 400
WS 2222	Self-adhesive Labels	300 x 400
WS 1222L	Rigid Plastic Sheet	400 x 600
WS 2222L	Self-adhesive Labels	400 x 600



Product Code:	Type:	Width x Height (mm):
WS 1223	Rigid Plastic Sheet	300 x 400
WS 2223	Self-adhesive Labels	300 x 400
WS 1223L	Rigid Plastic Sheet	400 x 600
WS 2223L	Self-adhesive Labels	400 x 600



Product Code:	Type:	Width x Height (mm):
WS 1224	Rigid Plastic Sheet	300 x 400
WS 2224	Self-adhesive Labels	300 x 400
WS 1224L	Rigid Plastic Sheet	400 x 600
WS 2224L	Self-adhesive Labels	400 x 600



Prohibition Signs

Definition of a prohibition safety signs.

- Instruct staff and visitors that certain behavior and actions are prohibited.



Product Code:	Type:	Width x Height (mm):
PS 1101	Rigid Plastic Sheet	300 x 400
PS 2101	Self-adhesive Labels	300 x 400
PS 1101L	Rigid Plastic Sheet	400 x 600
PS 2101L	Self-adhesive Labels	400 x 600



Product Code:	Type:	Width x Height (mm):
PS 1102	Rigid Plastic Sheet	300 x 400
PS 2102	Self-adhesive Labels	300 x 400
PS 1102L	Rigid Plastic Sheet	400 x 600
PS 2102L	Self-adhesive Labels	400 x 600



Product Code:	Type:	Width x Height (mm):
PS 1103	Rigid Plastic Sheet	300 x 400
PS 2103	Self-adhesive Labels	300 x 400
PS 1103L	Rigid Plastic Sheet	400 x 600
PS 2103L	Self-adhesive Labels	400 x 600



Product Code:	Type:	Width x Height (mm):
PS 1104	Rigid Plastic Sheet	300 x 400
PS 2104	Self-adhesive Labels	300 x 400
PS 1104L	Rigid Plastic Sheet	400 x 600
PS 2104L	Self-adhesive Labels	400 x 600



Product Code:	Type:	Width x Height (mm):
PS 1105	Rigid Plastic Sheet	300 x 400
PS 2105	Self-adhesive Labels	300 x 400
PS 1105L	Rigid Plastic Sheet	400 x 600
PS 2105L	Self-adhesive Labels	400 x 600



Product Code:	Type:	Width x Height (mm):
PS 1106	Rigid Plastic Sheet	300 x 400
PS 2106	Self-adhesive Labels	300 x 400
PS 1106L	Rigid Plastic Sheet	400 x 600
PS 2106L	Self-adhesive Labels	400 x 600



Product Code:	Type:	Width x Height (mm):
PS 1107	Rigid Plastic Sheet	300 x 400
PS 2107	Self-adhesive Labels	300 x 400
PS 1107L	Rigid Plastic Sheet	400 x 600
PS 2107L	Self-adhesive Labels	400 x 600



Product Code:	Type:	Width x Height (mm):
PS 1108	Rigid Plastic Sheet	300 x 400
PS 2108	Self-adhesive Labels	300 x 400
PS 1108L	Rigid Plastic Sheet	400 x 600
PS 2108L	Self-adhesive Labels	400 x 600



Product Code:	Type:	Width x Height (mm):
PS 1109	Rigid Plastic Sheet	300 x 400
PS 2109	Self-adhesive Labels	300 x 400
PS 1109L	Rigid Plastic Sheet	400 x 600
PS 2109L	Self-adhesive Labels	400 x 600



Product Code:	Type:	Width x Height (mm):
PS 1110	Rigid Plastic Sheet	300 x 400
PS 2110	Self-adhesive Labels	300 x 400
PS 1110L	Rigid Plastic Sheet	400 x 600
PS 2110L	Self-adhesive Labels	400 x 600



Product Code:	Type:	Width x Height (mm):
PS 1111	Rigid Plastic Sheet	300 x 400
PS 2111	Self-adhesive Labels	300 x 400
PS 1111L	Rigid Plastic Sheet	400 x 600
PS 2111L	Self-adhesive Labels	400 x 600



Product Code:	Type:	Width x Height (mm):
PS 1112	Rigid Plastic Sheet	300 x 400
PS 2112	Self-adhesive Labels	300 x 400
PS 1112L	Rigid Plastic Sheet	400 x 600
PS 2112L	Self-adhesive Labels	400 x 600



Product Code:	Type:	Width x Height (mm):
PS 1113	Rigid Plastic Sheet	300 x 400
PS 2113	Self-adhesive Labels	300 x 400
PS 1113L	Rigid Plastic Sheet	400 x 600
PS 2113L	Self-adhesive Labels	400 x 600



Product Code:	Type:	Width x Height (mm):
PS 1114	Rigid Plastic Sheet	300 x 400
PS 2114	Self-adhesive Labels	300 x 400
PS 1114L	Rigid Plastic Sheet	400 x 600
PS 2114L	Self-adhesive Labels	400 x 600



Product Code:	Type:	Width x Height (mm):
PS 1115	Rigid Plastic Sheet	300 x 400
PS 2115	Self-adhesive Labels	300 x 400
PS 1115L	Rigid Plastic Sheet	400 x 600
PS 2115L	Self-adhesive Labels	400 x 600



Product Code:	Type:	Width x Height (mm):
PS 1116	Rigid Plastic Sheet	300 x 400
PS 2116	Self-adhesive Labels	300 x 400
PS 1116L	Rigid Plastic Sheet	400 x 600
PS 2116L	Self-adhesive Labels	400 x 600



Product Code:	Type:	Width x Height (mm):
PS 1117	Rigid Plastic Sheet	300 x 400
PS 2117	Self-adhesive Labels	300 x 400
PS 1117L	Rigid Plastic Sheet	400 x 600
PS 2117L	Self-adhesive Labels	400 x 600



Product Code:	Type:	Width x Height (mm):
PS 1118	Rigid Plastic Sheet	300 x 200
PS 2118	Self-adhesive Labels	300 x 200



Product Code:	Type:	Width x Height (mm):
PD 1101	Rigid Plastic Sheet	300 x 100
PD 2101	Self-adhesive Labels	300 x 100



Product Code:	Type:	Width x Height (mm):
PD 1102	Rigid Plastic Sheet	300 x 100
PD 2102	Self-adhesive Labels	300 x 100



Product Code:	Type:	Width x Height (mm):
PD 1103	Rigid Plastic Sheet	300 x 100
PD 2103	Self-adhesive Labels	300 x 100



Product Code:	Type:	Width x Height (mm):
PD 1104	Rigid Plastic Sheet	300 x 100
PD 2104	Self-adhesive Labels	300 x 100



Product Code:	Type:	Width x Height (mm):
PD 1105	Rigid Plastic Sheet	300 x 100
PD 2105	Self-adhesive Labels	300 x 100



Product Code:	Type:	Width x Height (mm):
PD 1106	Rigid Plastic Sheet	300 x 100
PD 2106	Self-adhesive Labels	300 x 100



Product Code:	Type:	Width x Height (mm):
PD 1108	Rigid Plastic Sheet	300 x 100
PD 2108	Self-adhesive Labels	300 x 100



Product Code:	Type:	Width x Height (mm):
PD 1109	Rigid Plastic Sheet	300 x 100
PD 2109	Self-adhesive Labels	300 x 100



Product Code:	Type:	Width x Height (mm):
PD 1111	Rigid Plastic Sheet	300 x 100
PD 2111	Self-adhesive Labels	300 x 100



Multi-message Signs

- Perfect for areas and situations where more than one safety message is required.



Product Code:	Type:	Width x Height (mm):
WS 1268	Rigid Plastic Sheet	450 x 300
WS 2268	Self-adhesive Labels	450 x 300



Product Code:	Type:	Width x Height (mm):
MMS 1881	Rigid Plastic Sheet	400 x 300
MMS 2881	Self-adhesive Labels	400 x 300



Product Code:	Type:	Width x Height (mm):
MMS 1882	Rigid Plastic Sheet	400 x 300
MMS 2882	Self-adhesive Labels	400 x 300



Product Code:	Type:	Width x Height (mm):
MMS 1883	Rigid Plastic Sheet	300 x 400
MMS 2883	Self-adhesive Labels	300 x 400



Product Code:	Type:	Width x Height (mm):
MMS 1884	Rigid Plastic Sheet	300 x 400
MMS 2884	Self-adhesive Labels	300 x 400



Product Code:	Type:	Width x Height (mm):
MMS 1885	Rigid Plastic Sheet	300 x 400
MMS 2885	Self-adhesive Labels	300 x 400



Product Code:	Type:	Width x Height (mm):
MMS 1886	Rigid Plastic Sheet	300 x 400
MMS 2886	Self-adhesive Labels	300 x 400

Cylinder Storage Signs

- To identify & separate the "Empty" & "Full" cylinders where these compressed gases are stored.



Product Code:	Type:	Width x Height (mm):
GE 1001	Rigid Plastic Sheet	200 x 150
GE 2001	Self-adhesive Labels	200 x 150



Product Code:	Type:	Width x Height (mm):
GE 1002	Rigid Plastic Sheet	200 x 150
GE 2002	Self-adhesive Labels	200 x 150



Safe Procedure & First Aid Signs

Definition of a safe condition safety signs.
- For providing information about safety conditions.



Product Code:	Type:	Width x Height (mm):
SP 1901	Rigid Plastic Sheet	300 x 400
SP 2901	Self-adhesive Labels	300 x 400



Product Code:	Type:	Width x Height (mm):
SP 1902	Rigid Plastic Sheet	300 x 400
SP 2902	Self-adhesive Labels	300 x 400



Product Code:	Type:	Width x Height (mm):
SP 1903	Rigid Plastic Sheet	300 x 400
SP 2903	Self-adhesive Labels	300 x 400



Product Code:	Type:	Width x Height (mm):
SP 1904	Rigid Plastic Sheet	300 x 400
SP 2904	Self-adhesive Labels	300 x 400



Product Code:	Type:	Width x Height (mm):
SP 1905	Rigid Plastic Sheet	600 x 400
SP 2905	Self-adhesive Labels	600 x 400

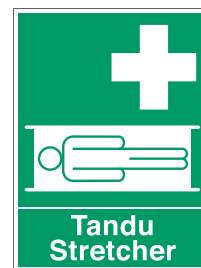

Product Code:	Type:	Width x Height (mm):
SP 1906	Rigid Plastic Sheet	300 x 400
SP 2906	Self-adhesive Labels	300 x 400



Product Code:	Type:	Width x Height (mm):
SP 1907	Rigid Plastic Sheet	400 x 300
SP 2907	Self-adhesive Labels	400 x 300



Product Code:	Type:	Width x Height (mm):
SP 1908	Rigid Plastic Sheet	600 x 400
SP 2908	Self-adhesive Labels	600 x 400



Product Code:	Type:	Width x Height (mm):
SP 1909	Rigid Plastic Sheet	600 x 400
SP 2909	Self-adhesive Labels	600 x 400



Product Code:	Type:	Width x Height (mm):
SP 1910	Rigid Plastic Sheet	400 x 600
SP 2910	Self-adhesive Labels	400 x 600



Product Code:	Type:	Width x Height (mm):
SP 1911	Rigid Plastic Sheet	1800 x 600
SP 2911	Self-adhesive Labels	1800 x 600



Product Code:	Type:	Width x Height (mm):
SP 1912	Rigid Plastic Sheet	75 x 100
SP 2912	Self-adhesive Labels	75 x 100



Product Code:	Type:	Width x Height (mm):
SP 1913	Rigid Plastic Sheet	75 x 100
SP 2913	Self-adhesive Labels	75 x 100



Product Code:	Type:	Width x Height (mm):
SP 1914	Rigid Plastic Sheet	200 x 200
SP 2914	Self-adhesive Labels	200 x 200



Emergency Escape Signs

Definition of a emergency escape signs.
- Clearly identify emergency and fire exit.



Product Code:	Type:	Width x Height (mm):
EES 1501	Rigid Plastic Sheet	450 x 150
EES 2501	Self-adhesive Labels	450 x 150



Product Code:	Type:	Width x Height (mm):
EES 1502	Rigid Plastic Sheet	450 x 150
EES 2502	Self-adhesive Labels	450 x 150



Product Code:	Type:	Width x Height (mm):
EES 1503	Rigid Plastic Sheet	450 x 150
EES 2503	Self-adhesive Labels	450 x 150



Product Code:	Type:	Width x Height (mm):
EES 1504	Rigid Plastic Sheet	450 x 150
EES 2504	Self-adhesive Labels	450 x 150



Product Code:	Type:	Width x Height (mm):
EES 1505	Rigid Plastic Sheet	450 x 150
EES 2505	Self-adhesive Labels	450 x 150



Product Code:	Type:	Width x Height (mm):
EES 1506	Rigid Plastic Sheet	450 x 150
EES 2506	Self-adhesive Labels	450 x 150



Product Code:	Type:	Width x Height (mm):
EES 1507	Rigid Plastic Sheet	450 x 150
EES 2507	Self-adhesive Labels	450 x 150



Product Code:	Type:	Width x Height (mm):
EES 1508	Rigid Plastic Sheet	300 x 150
EES 2508	Self-adhesive Labels	300 x 150



Product Code:	Type:	Width x Height (mm):
EES 1509	Rigid Plastic Sheet	300 x 150
EES 2509	Self-adhesive Labels	300 x 150



Product Code:	Type:	Width x Height (mm):
EES 1510	Rigid Plastic Sheet	300 x 150
EES 2510	Self-adhesive Labels	300 x 150



Product Code:	Type:	Width x Height (mm):
EES 1511	Rigid Plastic Sheet	300 x 150
EES 2511	Self-adhesive Labels	300 x 150



Product Code:	Type:	Width x Height (mm):
EES 1512	Rigid Plastic Sheet	300 x 150
EES 2512	Self-adhesive Labels	300 x 150



Product Code:	Type:	Width x Height (mm):
EES 1513	Rigid Plastic Sheet	300 x 150
EES 2513	Self-adhesive Labels	300 x 150



Product Code:	Type:	Width x Height (mm):
EES 1514	Rigid Plastic Sheet	300 x 150
EES 2514	Self-adhesive Labels	300 x 150



Product Code:	Type:	Width x Height (mm):
EES 1515	Rigid Plastic Sheet	300 x 150
EES 2515	Self-adhesive Labels	300 x 150



Product Code:	Type:	Width x Height (mm):
EES 1516	Rigid Plastic Sheet	150 x 150
EES 2516	Self-adhesive Labels	150 x 150



Product Code:	Type:	Width x Height (mm):
EES 1517	Rigid Plastic Sheet	150 x 150
EES 2517	Self-adhesive Labels	150 x 150



Product Code:	Type:	Width x Height (mm):
EES 1518	Rigid Plastic Sheet	450 x 150
EES 2518	Self-adhesive Labels	450 x 150



Photoluminescent Emergency Escape Signs

- These Photoluminescent material emits a clear and visible glow when there is power failure. It's requires no battery-power or any other triggering source for emission the glow. Upon exposure to light, natural or artificial, this photoluminescent material absorbs and stores light energy and then in the absence of light, this captivated light will released to give off a luminous glow over an extended period of time, generally several hours.
- A photoluminescent system is designed to provide continuous, visible direction to ensure orderly, expeditious, safe evacuation of a facility in the event of power failure or of smoke obscuring the exits or other disasters. Additionally, this system may assist the Fire Department personnel entering a facility to extinguish a fire and/or to assist in evacuation by providing a guidance pathway in areas of darkness.
- It can also be enormously useful in highlighting access to fire equipments or controls during periods of sudden darkness caused by fire or power failure or other emergency situations. In short, the purpose of Photoluminescent Escape/Guidance systems in the event of sudden darkness caused by the loss of power or smoke in building is to help minimise building occupants' disorientation and panic, by providing a Photoluminescent escape route marking system.



Product Code:	Type:	Width x Height (mm):
EES 1501LG	Rigid Plastic Sheet	450 x 150
EES 2501LG	Self-adhesive Labels	450 x 150



Product Code:	Type:	Width x Height (mm):
EES 1502LG	Rigid Plastic Sheet	450 x 150
EES 2502LG	Self-adhesive Labels	450 x 150



Product Code:	Type:	Width x Height (mm):
EES 1503LG	Rigid Plastic Sheet	450 x 150
EES 2503LG	Self-adhesive Labels	450 x 150



Product Code:	Type:	Width x Height (mm):
EES 1504LG	Rigid Plastic Sheet	450 x 150
EES 2504LG	Self-adhesive Labels	450 x 150



Product Code:	Type:	Width x Height (mm):
EES 1505LG	Rigid Plastic Sheet	450 x 150
EES 2505LG	Self-adhesive Labels	450 x 150



Product Code:	Type:	Width x Height (mm):
EES 1506LG	Rigid Plastic Sheet	450 x 150
EES 2506LG	Self-adhesive Labels	450 x 150



Product Code:	Type:	Width x Height (mm):
EES 1507LG	Rigid Plastic Sheet	450 x 150
EES 2507LG	Self-adhesive Labels	450 x 150



Product Code:	Type:	Width x Height (mm):
EES 1508LG	Rigid Plastic Sheet	300 x 150
EES 2508LG	Self-adhesive Labels	300 x 150



Product Code:	Type:	Width x Height (mm):
EES 1509LG	Rigid Plastic Sheet	300 x 150
EES 2509LG	Self-adhesive Labels	300 x 150



Product Code:	Type:	Width x Height (mm):
EES 1510LG	Rigid Plastic Sheet	300 x 150
EES 2510LG	Self-adhesive Labels	300 x 150



Product Code:	Type:	Width x Height (mm):
EES 1511LG	Rigid Plastic Sheet	300 x 150
EES 2511LG	Self-adhesive Labels	300 x 150



Product Code:	Type:	Width x Height (mm):
EES 1512LG	Rigid Plastic Sheet	300 x 150
EES 2512LG	Self-adhesive Labels	300 x 150



Product Code:	Type:	Width x Height (mm):
EES 1513LG	Rigid Plastic Sheet	300 x 150
EES 2513LG	Self-adhesive Labels	300 x 150



Product Code:	Type:	Width x Height (mm):
EES 1514LG	Rigid Plastic Sheet	300 x 150
EES 2514LG	Self-adhesive Labels	300 x 150



Product Code:	Type:	Width x Height (mm):
EES 1515LG	Rigid Plastic Sheet	300 x 150
EES 2515LG	Self-adhesive Labels	300 x 150



Product Code:	Type:	Width x Height (mm):
EES 1516LG	Rigid Plastic Sheet	150 x 150
EES 2516LG	Self-adhesive Labels	150 x 150



Product Code:	Type:	Width x Height (mm):
EES 1517LG	Rigid Plastic Sheet	150 x 150
EES 2517LG	Self-adhesive Labels	150 x 150

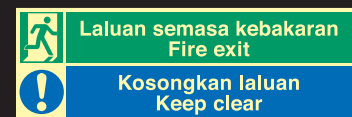

Product Code:	Type:	Width x Height (mm):
EES 1518LG	Rigid Plastic Sheet	450 x 150
EES 2518LG	Self-adhesive Labels	450 x 150



Photoluminescent IMO Safety Signs

Exceeds P.S.P.A Class A, DIN 67 510 Part 4 & IMO A.752(18)



Product Code:	Type:	Width x Height (mm):
IMO 1/15	Self-adhesive Labels	150 x 150
IMO 1/20	Self-adhesive Labels	200 x 200



Product Code:	Type:	Width x Height (mm):
IMO 2/15	Self-adhesive Labels	150 x 150
IMO 2/20	Self-adhesive Labels	200 x 200



Product Code:	Type:	Width x Height (mm):
IMO 3/15	Self-adhesive Labels	150 x 150
IMO 3/20	Self-adhesive Labels	200 x 200



Product Code:	Type:	Width x Height (mm):
IMO 4/15	Self-adhesive Labels	150 x 150
IMO 4/20	Self-adhesive Labels	200 x 200



Product Code:	Type:	Width x Height (mm):
IMO 5/15	Self-adhesive Labels	150 x 150
IMO 5/20	Self-adhesive Labels	200 x 200



Product Code:	Type:	Width x Height (mm):
IMO 6/15	Self-adhesive Labels	150 x 150
IMO 6/20	Self-adhesive Labels	200 x 200



Product Code:	Type:	Width x Height (mm):
IMO 7/15	Self-adhesive Labels	150 x 150
IMO 7/20	Self-adhesive Labels	200 x 200



Product Code:	Type:	Width x Height (mm):
IMO 8/15	Self-adhesive Labels	150 x 150
IMO 8/20	Self-adhesive Labels	200 x 200



Product Code:	Type:	Width x Height (mm):
IMO 9/15	Self-adhesive Labels	150 x 150
IMO 9/20	Self-adhesive Labels	200 x 200



Product Code:	Type:	Width x Height (mm):
IMO 10/15	Self-adhesive Labels	150 x 150
IMO 10/20	Self-adhesive Labels	200 x 200



Product Code:	Type:	Width x Height (mm):
IMO 11/15	Self-adhesive Labels	150 x 150
IMO 11/20	Self-adhesive Labels	200 x 200



Product Code:	Type:	Width x Height (mm):
IMO 12/15	Self-adhesive Labels	150 x 150
IMO 12/20	Self-adhesive Labels	200 x 200



Product Code:	Type:	Width x Height (mm):
IMO 13/15	Self-adhesive Labels	150 x 150
IMO 13/20	Self-adhesive Labels	200 x 200



Product Code:	Type:	Width x Height (mm):
IMO 14/15	Self-adhesive Labels	150 x 150
IMO 14/20	Self-adhesive Labels	200 x 200



Product Code:	Type:	Width x Height (mm):
IMO 15/15	Self-adhesive Labels	150 x 150
IMO 15/20	Self-adhesive Labels	200 x 200



Product Code:	Type:	Width x Height (mm):
IMO 16/15	Self-adhesive Labels	150 x 150
IMO 16/20	Self-adhesive Labels	200 x 200



Product Code:	Type:	Width x Height (mm):
IMO 17/15	Self-adhesive Labels	150 x 150
IMO 17/20	Self-adhesive Labels	200 x 200



Product Code:	Type:	Width x Height (mm):
IMO 18/15	Self-adhesive Labels	150 x 150
IMO 18/20	Self-adhesive Labels	200 x 200



Product Code:	Type:	Width x Height (mm):
IMO 19/15	Self-adhesive Labels	150 x 150
IMO 19/20	Self-adhesive Labels	200 x 200



Product Code:	Type:	Width x Height (mm):
IMO 20/15	Self-adhesive Labels	150 x 150
IMO 20/20	Self-adhesive Labels	200 x 200



Product Code:	Type:	Width x Height (mm):
IMO 21/15	Self-adhesive Labels	150 x 150
IMO 21/20	Self-adhesive Labels	200 x 200



Product Code:	Type:	Width x Height (mm):
IMO 25/15	Self-adhesive Labels	150 x 150
IMO 25/20	Self-adhesive Labels	200 x 200



Product Code:	Type:	Width x Height (mm):
IMO 26/15	Self-adhesive Labels	150 x 150
IMO 26/20	Self-adhesive Labels	200 x 200



Product Code:	Type:	Width x Height (mm):
IMO 27/15	Self-adhesive Labels	150 x 150
IMO 27/20	Self-adhesive Labels	200 x 200



Product Code:	Type:	Width x Height (mm):
IMO 28/15	Self-adhesive Labels	150 x 150
IMO 28/20	Self-adhesive Labels	200 x 200



Product Code:	Type:	Width x Height (mm):
IMO 29/15	Self-adhesive Labels	150 x 150
IMO 29/20	Self-adhesive Labels	200 x 200



Product Code:	Type:	Width x Height (mm):
IMO 30/15	Self-adhesive Labels	150 x 150
IMO 30/20	Self-adhesive Labels	200 x 200



Product Code:	Type:	Width x Height (mm):
IMO 31/15	Self-adhesive Labels	150 x 150
IMO 31/20	Self-adhesive Labels	200 x 200



Product Code:	Type:	Width x Height (mm):
IMO 32/15	Self-adhesive Labels	150 x 150
IMO 32/20	Self-adhesive Labels	200 x 200



Product Code:	Type:	Width x Height (mm):
IMO 33/15	Self-adhesive Labels	150 x 150
IMO 33/20	Self-adhesive Labels	200 x 200



Product Code:	Type:	Width x Height (mm):
IMO 34/15	Self-adhesive Labels	150 x 150
IMO 34/20	Self-adhesive Labels	200 x 200



Product Code:	Type:	Width x Height (mm):
IMO 35/15	Self-adhesive Labels	150 x 150
IMO 35/20	Self-adhesive Labels	200 x 200



Product Code:	Type:	Width x Height (mm):
IMO 36/15	Self-adhesive Labels	150 x 150
IMO 36/20	Self-adhesive Labels	200 x 200



Product Code:	Type:	Width x Height (mm):
IMO 37/15	Self-adhesive Labels	150 x 150
IMO 37/20	Self-adhesive Labels	200 x 200



Product Code:	Type:	Width x Height (mm):
IMO 38/15	Self-adhesive Labels	150 x 150
IMO 38/20	Self-adhesive Labels	200 x 200



Product Code:	Type:	Width x Height (mm):
IMO 39/15	Self-adhesive Labels	150 x 150
IMO 39/20	Self-adhesive Labels	200 x 200



Product Code:	Type:	Width x Height (mm):
IMO 40/15	Self-adhesive Labels	150 x 150
IMO 40/20	Self-adhesive Labels	200 x 200



Product Code:	Type:	Width x Height (mm):
IMO 41/15	Self-adhesive Labels	150 x 150
IMO 41/20	Self-adhesive Labels	200 x 200



Product Code:	Type:	Width x Height (mm):
IMO 42/15	Self-adhesive Labels	150 x 150
IMO 42/20	Self-adhesive Labels	200 x 200

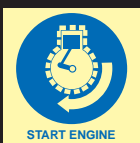

Product Code:	Type:	Width x Height (mm):
IMO 43/15	Self-adhesive Labels	150 x 150
IMO 43/20	Self-adhesive Labels	200 x 200









Product Code:	Type:	Width x Height (mm):
IMO 44/15	Self-adhesive Labels	150 x 150
IMO 44/20	Self-adhesive Labels	200 x 200



Product Code:	Type:	Width x Height (mm):
IMO 45/15	Self-adhesive Labels	150 x 150
IMO 45/20	Self-adhesive Labels	200 x 200



																													
<table border="1"> <thead> <tr> <th>Product Code:</th> <th>Type:</th> <th>Width x Height (mm):</th> </tr> </thead> <tbody> <tr> <td>IMO 46/15</td> <td>Self-adhesive Labels</td> <td>150 x 150</td> </tr> <tr> <td>IMO 46/20</td> <td>Self-adhesive Labels</td> <td>200 x 200</td> </tr> </tbody> </table>	Product Code:	Type:	Width x Height (mm):	IMO 46/15	Self-adhesive Labels	150 x 150	IMO 46/20	Self-adhesive Labels	200 x 200	<table border="1"> <thead> <tr> <th>Product Code:</th> <th>Type:</th> <th>Width x Height (mm):</th> </tr> </thead> <tbody> <tr> <td>IMO 47/15</td> <td>Self-adhesive Labels</td> <td>150 x 150</td> </tr> <tr> <td>IMO 47/20</td> <td>Self-adhesive Labels</td> <td>200 x 200</td> </tr> </tbody> </table>	Product Code:	Type:	Width x Height (mm):	IMO 47/15	Self-adhesive Labels	150 x 150	IMO 47/20	Self-adhesive Labels	200 x 200	<table border="1"> <thead> <tr> <th>Product Code:</th> <th>Type:</th> <th>Width x Height (mm):</th> </tr> </thead> <tbody> <tr> <td>IMO 48/15</td> <td>Self-adhesive Labels</td> <td>150 x 150</td> </tr> <tr> <td>IMO 48/20</td> <td>Self-adhesive Labels</td> <td>200 x 200</td> </tr> </tbody> </table>	Product Code:	Type:	Width x Height (mm):	IMO 48/15	Self-adhesive Labels	150 x 150	IMO 48/20	Self-adhesive Labels	200 x 200
Product Code:	Type:	Width x Height (mm):																											
IMO 46/15	Self-adhesive Labels	150 x 150																											
IMO 46/20	Self-adhesive Labels	200 x 200																											
Product Code:	Type:	Width x Height (mm):																											
IMO 47/15	Self-adhesive Labels	150 x 150																											
IMO 47/20	Self-adhesive Labels	200 x 200																											
Product Code:	Type:	Width x Height (mm):																											
IMO 48/15	Self-adhesive Labels	150 x 150																											
IMO 48/20	Self-adhesive Labels	200 x 200																											
																													
<table border="1"> <thead> <tr> <th>Product Code:</th> <th>Type:</th> <th>Width x Height (mm):</th> </tr> </thead> <tbody> <tr> <td>IMO 49/15</td> <td>Self-adhesive Labels</td> <td>150 x 150</td> </tr> <tr> <td>IMO 49/20</td> <td>Self-adhesive Labels</td> <td>200 x 200</td> </tr> </tbody> </table>	Product Code:	Type:	Width x Height (mm):	IMO 49/15	Self-adhesive Labels	150 x 150	IMO 49/20	Self-adhesive Labels	200 x 200	<table border="1"> <thead> <tr> <th>Product Code:</th> <th>Type:</th> <th>Width x Height (mm):</th> </tr> </thead> <tbody> <tr> <td>IMO 50/15</td> <td>Self-adhesive Labels</td> <td>150 x 150</td> </tr> <tr> <td>IMO 50/20</td> <td>Self-adhesive Labels</td> <td>200 x 200</td> </tr> </tbody> </table>	Product Code:	Type:	Width x Height (mm):	IMO 50/15	Self-adhesive Labels	150 x 150	IMO 50/20	Self-adhesive Labels	200 x 200	<table border="1"> <thead> <tr> <th>Product Code:</th> <th>Type:</th> <th>Width x Height (mm):</th> </tr> </thead> <tbody> <tr> <td>IMO 51/15</td> <td>Self-adhesive Labels</td> <td>150 x 150</td> </tr> <tr> <td>IMO 51/20</td> <td>Self-adhesive Labels</td> <td>200 x 200</td> </tr> </tbody> </table>	Product Code:	Type:	Width x Height (mm):	IMO 51/15	Self-adhesive Labels	150 x 150	IMO 51/20	Self-adhesive Labels	200 x 200
Product Code:	Type:	Width x Height (mm):																											
IMO 49/15	Self-adhesive Labels	150 x 150																											
IMO 49/20	Self-adhesive Labels	200 x 200																											
Product Code:	Type:	Width x Height (mm):																											
IMO 50/15	Self-adhesive Labels	150 x 150																											
IMO 50/20	Self-adhesive Labels	200 x 200																											
Product Code:	Type:	Width x Height (mm):																											
IMO 51/15	Self-adhesive Labels	150 x 150																											
IMO 51/20	Self-adhesive Labels	200 x 200																											

Fire Signs

Definition of a fire signs.

- Clearly identify the location of your fire fighting equipment.



Product Code:	Type:	Width x Height (mm):
FS 1728S	Rigid Plastic Sheet	150 x 150
FS 2728S	Self-adhesive Labels	150 x 150
FS 1728	Rigid Plastic Sheet	200 x 200
FS 2728	Self-adhesive Labels	200 x 200



Product Code:	Type:	Width x Height (mm):
FS 1738S	Rigid Plastic Sheet	150 x 150
FS 2738S	Self-adhesive Labels	150 x 150
FS 1738	Rigid Plastic Sheet	200 x 200
FS 2738	Self-adhesive Labels	200 x 200



Product Code:	Type:	Width x Height (mm):
FS 1748S	Rigid Plastic Sheet	150 x 150
FS 2748S	Self-adhesive Labels	150 x 150
FS 1748	Rigid Plastic Sheet	200 x 200
FS 2748	Self-adhesive Labels	200 x 200



Product Code:	Type:	Width x Height (mm):
FS 1758S	Rigid Plastic Sheet	150 x 150
FS 2758S	Self-adhesive Labels	150 x 150
FS 1758	Rigid Plastic Sheet	200 x 200
FS 2758	Self-adhesive Labels	200 x 200



Product Code:	Type:	Width x Height (mm):
FS 1768S	Rigid Plastic Sheet	150 x 150
FS 2768S	Self-adhesive Labels	150 x 150
FS 1768	Rigid Plastic Sheet	200 x 200
FS 2768	Self-adhesive Labels	200 x 200



Product Code:	Type:	Width x Height (mm):
FS 1778S	Rigid Plastic Sheet	150 x 150
FS 2778S	Self-adhesive Labels	150 x 150
FS 1778	Rigid Plastic Sheet	200 x 200
FS 2778	Self-adhesive Labels	200 x 200



Product Code:	Type:	Width x Height (mm):
FS 1788S	Rigid Plastic Sheet	150 x 150
FS 2788S	Self-adhesive Labels	150 x 150
FS 1788	Rigid Plastic Sheet	200 x 200
FS 2788	Self-adhesive Labels	200 x 200



Product Code:	Type:	Width x Height (mm):
FS 1798S	Rigid Plastic Sheet	150 x 150
FS 2798S	Self-adhesive Labels	150 x 150
FS 1798	Rigid Plastic Sheet	200 x 200
FS 2798	Self-adhesive Labels	200 x 200



Can't see what you need? Custom made?
 Call our customer service dept. for assistant or contact our nearest authorised distributor.



Product Code:	Type:	Width x Height (mm):
FS 1728LGS	Rigid Plastic Sheet	150 x 150
FS 2728LGS	Self-adhesive Labels	150 x 150
FS 1728LG	Rigid Plastic Sheet	200 x 200
FS 2728LG	Self-adhesive Labels	200 x 200

Product Code:	Type:	Width x Height (mm):
FS 1738LGS	Rigid Plastic Sheet	150 x 150
FS 2738LGS	Self-adhesive Labels	150 x 150
FS 1738LG	Rigid Plastic Sheet	200 x 200
FS 2738LG	Self-adhesive Labels	200 x 200

Product Code:	Type:	Width x Height (mm):
FS 1748LGS	Rigid Plastic Sheet	150 x 150
FS 2748LGS	Self-adhesive Labels	150 x 150
FS 1748LG	Rigid Plastic Sheet	200 x 200
FS 2748LG	Self-adhesive Labels	200 x 200



Product Code:	Type:	Width x Height (mm):
FS 1758LGS	Rigid Plastic Sheet	150 x 150
FS 2758LGS	Self-adhesive Labels	150 x 150
FS 1758LG	Rigid Plastic Sheet	200 x 200
FS 2758LG	Self-adhesive Labels	200 x 200

Product Code:	Type:	Width x Height (mm):
FS 1768LGS	Rigid Plastic Sheet	150 x 150
FS 2768LGS	Self-adhesive Labels	150 x 150
FS 1768LG	Rigid Plastic Sheet	200 x 200
FS 2768LG	Self-adhesive Labels	200 x 200

Product Code:	Type:	Width x Height (mm):
FS 1778LGS	Rigid Plastic Sheet	150 x 150
FS 2778LGS	Self-adhesive Labels	150 x 150
FS 1778LG	Rigid Plastic Sheet	200 x 200
FS 2778LG	Self-adhesive Labels	200 x 200



Product Code:	Type:	Width x Height (mm):
FS 1788LGS	Rigid Plastic Sheet	150 x 150
FS 2788LGS	Self-adhesive Labels	150 x 150
FS 1788LG	Rigid Plastic Sheet	200 x 200
FS 2788LG	Self-adhesive Labels	200 x 200

Product Code:	Type:	Width x Height (mm):
FS 1798LGS	Rigid Plastic Sheet	150 x 150
FS 2798LGS	Self-adhesive Labels	150 x 150
FS 1798LG	Rigid Plastic Sheet	200 x 200
FS 2798LG	Self-adhesive Labels	200 x 200



Product Code:	Type:	Width x Height (mm):
FS 1848	Rigid Plastic Sheet	100 x 300
FS 2848	Self-adhesive Labels	100 x 300
FS 1848LG	Rigid Plastic Sheet	100 x 300
FS 2848LG	Self-adhesive Labels	100 x 300

Product Code:	Type:	Width x Height (mm):
FS 1858	Rigid Plastic Sheet	100 x 300
FS 2858	Self-adhesive Labels	100 x 300
FS 1858LG	Rigid Plastic Sheet	100 x 300
FS 2858LG	Self-adhesive Labels	100 x 300



Product Code:	Type:	Width x Height (mm):
FS 1868	Rigid Plastic Sheet	300 x 400
FS 2868	Self-adhesive Labels	300 x 400



Projecting 3D Signs

- Project out 140mm, each sign face measures 200 x 200mm and the total sign width, when fixed, is 320mm.
- 2.5mm thick High-Impact Plastic and 4 pre-drilled holes for screw fixing.

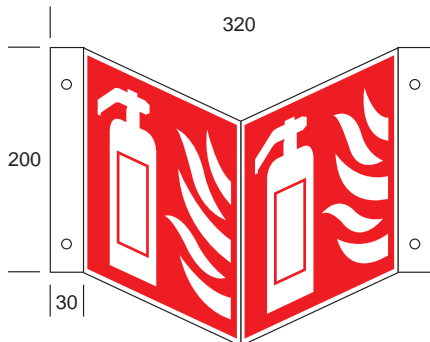

Product Code: 3D 768
Type: Projecting 3D Sign
Width x Height (mm): 200 x 320



Product Code: 3D 769
Type: Projecting 3D Sign
Width x Height (mm): 200 x 320



Product Code: 3D 770
Type: Projecting 3D Sign
Width x Height (mm): 200 x 320



Product Code: 3D 771
Type: Projecting 3D Sign
Width x Height (mm): 200 x 320



Product Code: 3D 772
Type: Projecting 3D Sign
Width x Height (mm): 200 x 320

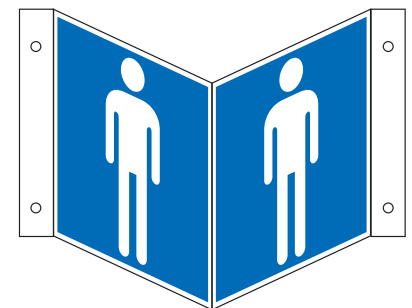

Product Code: 3D 773
Type: Projecting 3D Sign
Width x Height (mm): 200 x 320



Product Code: 3D 774
Type: Projecting 3D Sign
Width x Height (mm): 200 x 320



Product Code: 3D 775
Type: Projecting 3D Sign
Width x Height (mm): 200 x 320

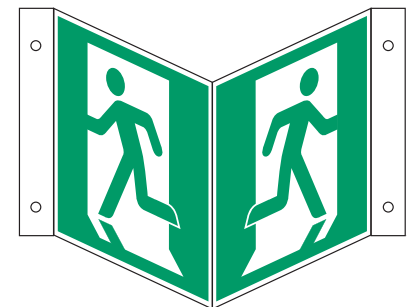

Product Code: 3D 776
Type: Projecting 3D Sign
Width x Height (mm): 200 x 320

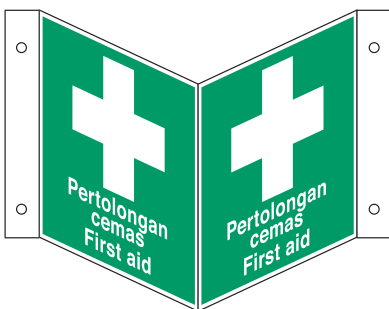

Product Code: 3D 777
Type: Projecting 3D Sign
Width x Height (mm): 200 x 320



Product Code: 3D 778
Type: Projecting 3D Sign
Width x Height (mm): 200 x 320



Product Code: 3D 779
Type: Projecting 3D Sign
Width x Height (mm): 200 x 320



Hazardous Substances Labels

- Conform to all transportation regulations.
- Internationally recognised symbols are required on packages, vehicles, tankers and freight containers for all model of transport of dangerous goods. Available only in self-adhesive labels.



Product Code:	Type:	Width x Height (mm):
HS 2140S	Self-adhesive Labels	100 x 100
HS 2140	Self-adhesive Labels	140 x 140



Product Code:	Type:	Width x Height (mm):
HS 2141S	Self-adhesive Labels	100 x 100
HS 2141	Self-adhesive Labels	140 x 140



Product Code:	Type:	Width x Height (mm):
HS 2142S	Self-adhesive Labels	100 x 100
HS 2142	Self-adhesive Labels	140 x 140



Product Code:	Type:	Width x Height (mm):
HS 2143S	Self-adhesive Labels	100 x 100
HS 2143	Self-adhesive Labels	140 x 140



Product Code:	Type:	Width x Height (mm):
HS 2144S	Self-adhesive Labels	100 x 100
HS 2144	Self-adhesive Labels	140 x 140



Product Code:	Type:	Width x Height (mm):
HS 2145S	Self-adhesive Labels	100 x 100
HS 2145	Self-adhesive Labels	140 x 140



Product Code:	Type:	Width x Height (mm):
HS 2146S	Self-adhesive Labels	100 x 100
HS 2146	Self-adhesive Labels	140 x 140



Product Code:	Type:	Width x Height (mm):
HS 2147S	Self-adhesive Labels	100 x 100
HS 2147	Self-adhesive Labels	140 x 140



Product Code:	Type:	Width x Height (mm):
HS 2148S	Self-adhesive Labels	100 x 100
HS 2148	Self-adhesive Labels	140 x 140



Product Code:	Type:	Width x Height (mm):
HS 2149S	Self-adhesive Labels	100 x 100
HS 2149	Self-adhesive Labels	140 x 140



Product Code:	Type:	Width x Height (mm):
HS 2150S	Self-adhesive Labels	100 x 100
HS 2150	Self-adhesive Labels	140 x 140



Product Code:	Type:	Width x Height (mm):
HS 2151S	Self-adhesive Labels	100 x 100
HS 2151	Self-adhesive Labels	140 x 140



Product Code:	Type:	Width x Height (mm):
HS 2152S	Self-adhesive Labels	100 x 100
HS 2152	Self-adhesive Labels	140 x 140



Product Code:	Type:	Width x Height (mm):
HS 2153S	Self-adhesive Labels	100 x 100
HS 2153	Self-adhesive Labels	140 x 140



Product Code:	Type:	Width x Height (mm):
HS 2154S	Self-adhesive Labels	100 x 100
HS 2154	Self-adhesive Labels	140 x 140



Identification, Maintenance & Lockout Tags

- Resist chemicals and abrasion
- To pinpoint potential hazardous or on-the-spot identification of safety measure.
- Made of sturdy plastic material withstands all weather conditions oils & grease.
- Attach to machine or equipment using a nylon tie.
- Advisable to use permanent marker pen to write details onto these tags.



Product Code: DT 11361 Type: Rigid Plastic Sheet Width x Height (mm): 89 x 146



Product Code: DT 11362 Type: Rigid Plastic Sheet Width x Height (mm): 89 x 146

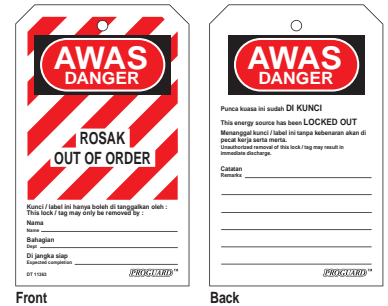

Product Code: DT 11363 Type: Rigid Plastic Sheet Width x Height (mm): 89 x 146



Product Code: DT 11364 Type: Rigid Plastic Sheet Width x Height (mm): 89 x 146



Product Code: DT 11365 Type: Rigid Plastic Sheet Width x Height (mm): 89 x 146



Product Code: DT 11366 Type: Rigid Plastic Sheet Width x Height (mm): 89 x 146



Product Code: DT 11367 Type: Rigid Plastic Sheet Width x Height (mm): 89 x 146

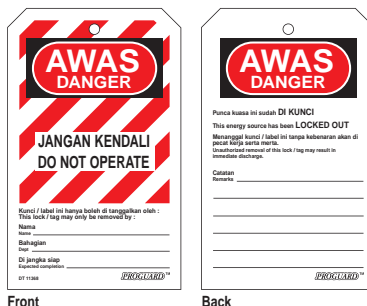

Product Code: DT 11368 Type: Rigid Plastic Sheet Width x Height (mm): 89 x 146

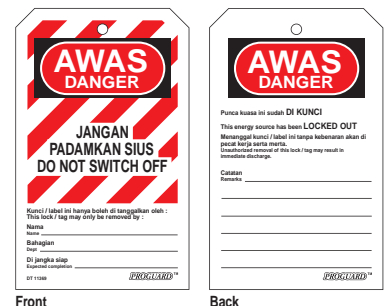

Product Code: DT 11369 Type: Rigid Plastic Sheet Width x Height (mm): 89 x 146



Product Code: DT 11370 Type: Rigid Plastic Sheet Width x Height (mm): 89 x 146



Product Code: DT Custom Type: Rigid Plastic Sheet Width x Height (mm): 89 x 146



Product Code: DT Plain Type: Rigid Plastic Sheet Width x Height (mm): 89 x 146



Printed Barrier Tapes

- Protects staffs & visitors by highlighting danger & hazardous areas. Highly visible and extremely durable. Made of Polyethylene material which can stretches up to twice its normal length before breaking.



Product Code:	Type:	Width x Height (mm):
PBT 10	Printed Barrier Tapes Awas Di Larang Masuk Caution No Admittance	76 x 305m (approx.)



Product Code:	Type:	Width x Height (mm):
PBT 20	Printed Barrier Tapes Awas Caution	76 x 305m (approx.)



Product Code:	Type:	Width x Height (mm):
PBT 30	Printed Barrier Tapes Awas Caution	76 x 305m (approx.)



Product Code:	Type:	Width x Height (mm):
PBT 40	Printed Barrier Tapes Bahaya Danger	76 x 305m (approx.)



Product Code:	Type:	Width x Height (mm):
PBT 50	Printed Barrier Tape Awas/ Caution	76 x 305m (approx.)



Product Code:	Type:	Width x Height (mm):
PBT 60	Printed Barrier Tapes Awas Di Larang Masuk Caution No Admittance	76 x 305m (approx.)

Non-Printed Barrier Tapes

- Used for general marking and highlighting obstructions. Made of Polyethylene material which can stretches up to twice its normal length before breaking.



Product Code:	Type:	Width x Height (mm):
NBT 76BY	Non-Printed Barrier Tapes	76 x 305m (approx.)

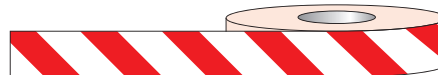

Product Code:	Type:	Width x Height (mm):
NBT 76RW	Non-Printed Barrier Tapes	76 x 305m (approx.)

Economic Barrier Tapes

- Used for general marking and temporary highlighting obstructions. Made of Polypropylene material.



Product Code:	Type:	Width x Height (mm):
EBT 76BY	Economic Barrier Tapes	76 x 250m (approx.)

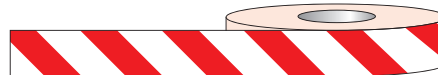

Product Code:	Type:	Width x Height (mm):
EBT 76RW	Economic Barrier Tapes	76 x 250m (approx.)



Underground Warning Tapes

- is buried 12" to 18" below ground level. Digging crews received warning of buried lines and cables, allowing a margin of safety between the tapes and the buried lines. These tapes are very economical, tough, easily seen or identified.



Product Code:	Type:	Width x Height (mm):
UWT 150	Underground Warning Tapes Bahaya! Kabel Letrik Di Bawah Danger! Electric Cable Below	150 x 305m (approx.)



Product Code:	Type:	Width x Height (mm):
UWT 151	Underground Warning Tapes Bahaya! Paip Gas Di Bawah Danger! Buried Gas Line	150 x 305m (approx.)

Adhesive Floor Tapes

- These floor tapes are economical but durable. Ideal for warehouse, loading bays, corridors, identify hazards, fire equipment & highlighting obstructions. Apply to clean & dry surfaces within minutes.



Product Code:	Type:	Width x Height (mm):
AFT 48 BY	Adhesive Floor Tapes	48 x 33 m
AFT 72 BY	Adhesive Floor Tapes	72 x 33 m
AFT 96 BY	Adhesive Floor Tapes	96 x 33 m

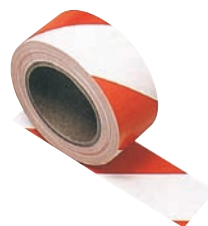

Product Code:	Type:	Width x Height (mm):
AFT 48 RW	Adhesive Floor Tapes	48 x 33 m
AFT 72 RW	Adhesive Floor Tapes	72 x 33 m
AFT 96 RW	Adhesive Floor Tapes	96 x 33 m



**Can't see
what you need?
Custom made?**

Call our customer service dept.
for assistant or contact our
nearest authorised distributor.



Anti-Slip Floor Tapes

- Provides maximum skid resistance. Versatile & suitable for entry & exit ways, mark aisles, staircases or even ladders that needs a skid-resistant surface. Adhesive backed. Applies easily to most areas.



5055BYH



5060RWH



5065BSH



5070BCH

Product Code:	Description:	Packing:
5055BYH	50mm x 18.3m Black/Yellow Hazard Anti-Slip Tape	1 roll
5060RWH	50mm x 18.3m Red/White Hazard Anti-Slip Tape	1 roll
5065BSH	50mm x 18.3m Black Standard Anti-Slip Tape	1 roll
5070BCH	50mm x 18.3m Black Coarse Anti-Slip Tape	1 roll

Glow In The Dark Anti-Slip Floor Tapes

- Reduces risk of slips & falls. Versatile & suitable for entryways, mark aisles, staircases or even ladders that needs a skid-resistant surface. Excellent Photoluminescent capability. Adhesive backed. Applies throughout your premises to direct personnel safely along emergency routes during a power failure.

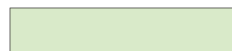
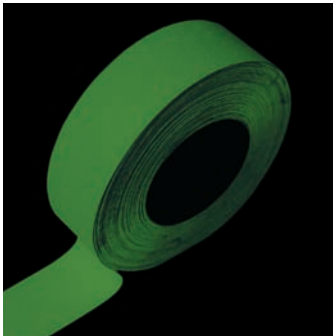

6050PLG



6060PLGH

Product Code:	Description:	Packing:
6050PLG	50mm x 18.3m Plain Glow In The Dark Anti-Slip Tape	1 roll
6060PLGH	50mm x 18.3m Black/White Hazard Glow In The Dark Anti-Slip Tape	1 roll

Anti-Slip Floor Signs

- Border floor signs have eye-catching diagonal striped edges to warn employees or visitors around the stairways, step areas, entry ways and walk areas.

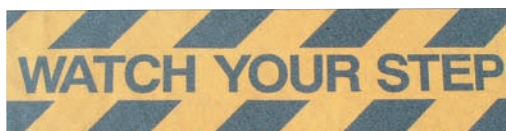

Product Code:	Description:	Packing:
ASFS3276	Watch Your Step Anti-Slip Floor Sign	5 pcs/pkt
ASFS3277	Caution Anti-Slip Floor Sign	5 pcs/pkt

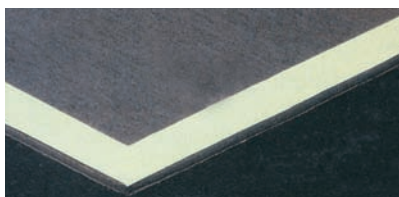

Can't see what you need? Custom made?

Call our customer service dept. for assistant or contact our nearest authorised distributor.



Safety Floor Signs Malaysia Design Pending No: 02-00402

- Printed on both side for maximum visibility.
- Made of sturdy plastic material withstand all weather condition.
- Ideal for maintenance crews to cordoning off hazardous areas in factories and public buildings.
- The strong-hinged construction enables quick set up and folds for easy storage.



Product Code: SFS 1501
Type: Polypropylene Material
Width x Height (mm): 300 x 670 x 32



Product Code: SFS 1502
Type: Polypropylene Material
Width x Height (mm): 300 x 670 x 32



Product Code: SFS 1503
Type: Polypropylene Material
Width x Height (mm): 300 x 670 x 32



Product Code: SFS 1504
Type: Polypropylene Material
Width x Height (mm): 300 x 670 x 32



Product Code: SFS 1505
Type: Polypropylene Material
Width x Height (mm): 300 x 670 x 32



Product Code: SFS 1506
Type: Polypropylene Material
Width x Height (mm): 300 x 670 x 32



Product Code: SFS 1601
Type: Polypropylene Material
Width x Height (mm): 300 x 670 x 32



Product Code: SFS 1602
Type: Polypropylene Material
Width x Height (mm): 300 x 670 x 32



Product Code: SFS 1605
Type: Polypropylene Material
Width x Height (mm): 300 x 670 x 32



Product Code: SFS 1606
Type: Polypropylene Material
Width x Height (mm): 300 x 670 x 32



Product Code: SFS 1607
Type: Polypropylene Material
Width x Height (mm): 300 x 670 x 32



Product Code: SFS 1608
Type: Polypropylene Material
Width x Height (mm): 300 x 670 x 32



Product Code: SFS 1609
Type: Polypropylene Material
Width x Height (mm): 300 x 670 x 32



Product Code: SFS Custom
Type: Polypropylene Material
Width x Height (mm): 300 x 670 x 32



Product Code: SFS Plain
Type: Polypropylene Material
Width x Height (mm): 300 x 670 x 32

* Please contact our customer service department or our authorised distributor to discuss your printing requirements.



Packaging, Information Signs

- Convey information with a simple message across.



Product Code:	Type:	Width x Height (mm):
IS 2401	Self-adhesive Labels	75 x 100



Product Code:	Type:	Width x Height (mm):
IS 2402	Self-adhesive Labels	75 x 100

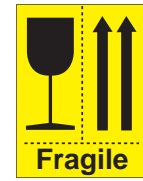

Product Code:	Type:	Width x Height (mm):
IS 2403	Self-adhesive Labels	75 x 100



Product Code:	Type:	Width x Height (mm):
IS 2404	Self-adhesive Labels	75 x 100



Product Code:	Type:	Width x Height (mm):
IS 1405	Rigid Plastic Sheet	200 x 200
IS 2405	Self-adhesive Labels	200 x 200



Product Code:	Type:	Width x Height (mm):
IS 1406	Rigid Plastic Sheet	200 x 200
IS 2406	Self-adhesive Labels	200 x 200



Product Code:	Type:	Width x Height (mm):
IS 1407	Rigid Plastic Sheet	200 x 200
IS 2407	Self-adhesive Labels	200 x 200



Product Code:	Type:	Width x Height (mm):
IS 1408	Rigid Plastic Sheet	200 x 200
IS 2408	Self-adhesive Labels	200 x 200



Product Code:	Type:	Width x Height (mm):
IS 1409	Rigid Plastic Sheet	200 x 200
IS 2409	Self-adhesive Labels	200 x 200



Product Code:	Type:	Width x Height (mm):
IS 1407	Rigid Plastic Sheet	200 x 200
IS 2407	Self-adhesive Labels	200 x 200



Product Code:	Type:	Width x Height (mm):
IS 1408	Rigid Plastic Sheet	200 x 200
IS 2408	Self-adhesive Labels	200 x 200



Product Code:	Type:	Width x Height (mm):
IS 1409	Rigid Plastic Sheet	200 x 200
IS 2409	Self-adhesive Labels	200 x 200

Photoluminescent Tapes

- These signs are used in identification of escape route, fire equipments, zone marking, handrail marking, safe conditions, etc.



Product Code:	Type:	Width x Height (mm):
T 3	Way Finding Tapes	40 x 10 m (approx.)
T 4	Way Finding Tapes	80 x 10 m (approx.)



Product Code:	Type:	Width x Height (mm):
T 5	Arrow Tapes	40 x 10 m (approx.)
T 6	Arrow Tapes	80 x 10 m (approx.)



Product Code:	Type:	Width x Height (mm):
T 7	Green Diagonal Tapes	40 x 10 m (approx.)
T 8	Green Diagonal Tapes	80 x 10 m (approx.)



Product Code:	Type:	Width x Height (mm):
T 11	Red Diagonal Tapes	40 x 10 m (approx.)
T 12	Red Diagonal Tapes	80 x 10 m (approx.)



Product Code:	Type:	Width x Height (mm):
DT 1	Arrow Route Markers	60 diameter
DT 2	Arrow Route Markers	80 diameter



Product Code:	Type:	Width x Height (mm):
DT 5	Foot Route Markers	250 x 100
DT 6	Foot Route Markers	250 x 100



Safetag™ Scaffold Tag System Malaysia Design Pending 02-00120

- Widely used and worldwide recognised as a reliable safety system to assist with the controlling of scaffolding from first build to dismantle.
- Provides a clear inspection trail giving integrity and control of work carried out by authorised & competent personnel to take prompt corrective measures to eliminate scaffold accidents.
 - Provides systematic, traceability, avoid irregularities and compliance to safety requirements.
 - Saves valuable time when preparing safety audits & safety inspection.
 - Reasonable priced for a system that reduce unforeseen mishaps & saves lives.
 - User friendly and resistant to all types of weather.

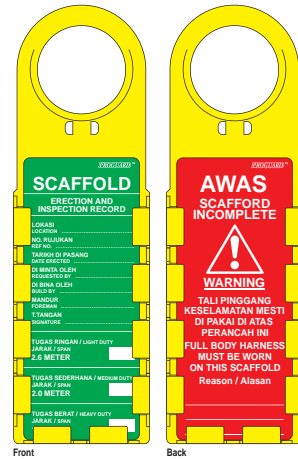
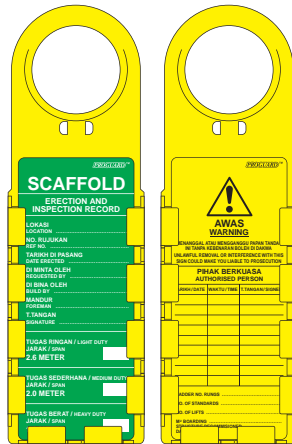
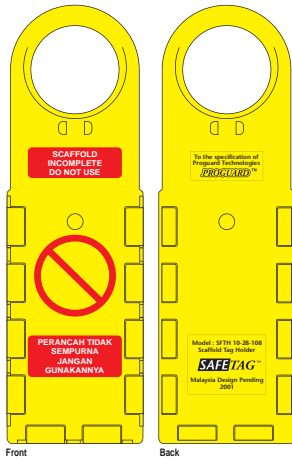
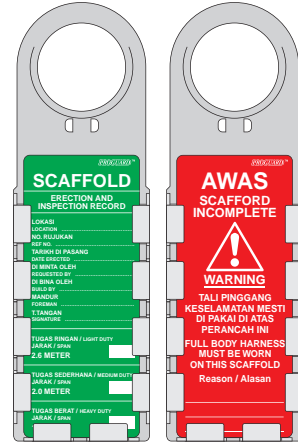
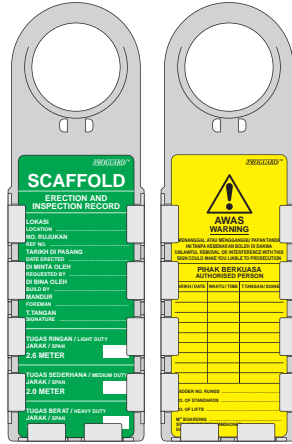
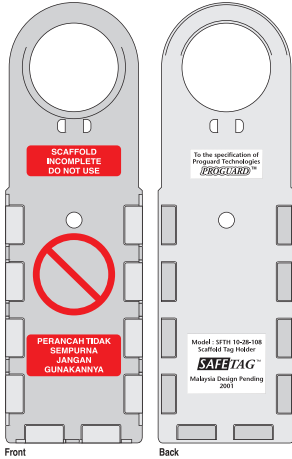

Product Code:	Type:	Width x Height (mm):
STH 10-28-108	Scaffold Tag/ 15pcs/box (White)	93 x 305
STH 10-38-198	Scaffold Tag/ 15pcs/box (yellow)	93 x 305

Product Code:	Type:	Width x Height (mm):
STH 10-28-108GY	Scaffold Tag/ 15pcs/box (White)	93 x 305
STH 10-38-198GY	Scaffold Tag/ 15pcs/box (yellow)	93 x 305

Product Code:	Type:	Width x Height (mm):
STH 10-28-108GR	Scaffold Tag/ 15pcs/box (White)	93 x 305
STH 10-38-198GR	Scaffold Tag/ 15pcs/box (yellow)	93 x 305

Custom Printing Tags

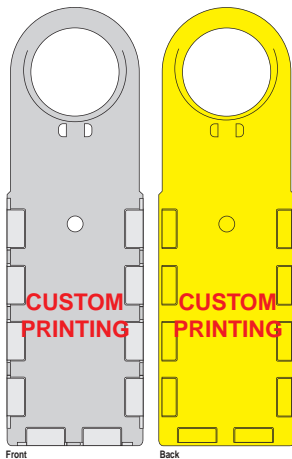

Product Code:	Type:	Width x Height (mm):
CMTH 10-20-000	Custom Made Tag/ 15pcs/box (White)	93 x 305
CMTH 10-30-000	Custom Made Tag/ 15pcs/box (yellow)	93 x 305

Door Tags

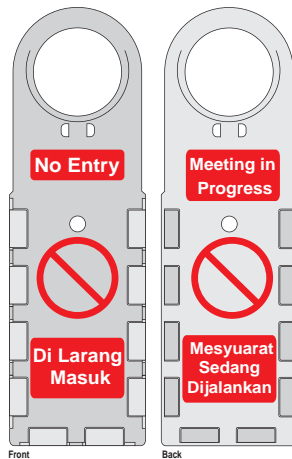

Product Code:	Type:	Width x Height (mm):
DT-1	Door Tag/ 15pcs/box (White)	93 x 305
DT-2	Door Tag/ 15pcs/box (White)	93 x 305



Hotels & offices identification door tags. Custom made company logo & printing are also available on request. Please contact our customer service department or our authorised distributor to discuss your printing requirements.



Replacement Tags

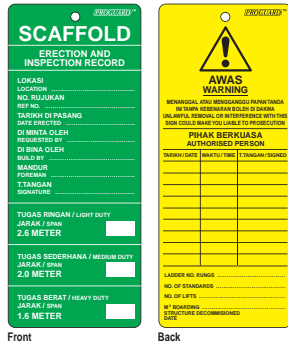

Product Code: ST 12300GY Type: Rigid Plastic Sheet Width x Height (mm): 80 x 195

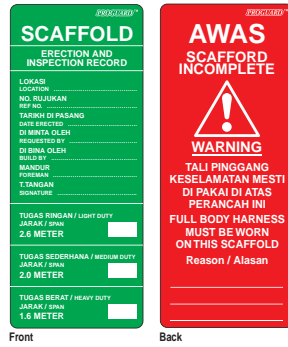

Product Code: ST 12301GR Type: Rigid Plastic Sheet Width x Height (mm): 80 x 195

HOW TO USE: 4 level inspection system

- 1) Plain Tag Holder - Under construction/ dismantling/failed inspection.
- 2) Green/Red Tag - Warning/Indicate unsafe. Advise on use of safety harness.
- 3) Green/Yellow Tag - Construction Complete. Indicate safe to use.
- 4) Regular inspection will be recorded on the yellow tag.

Economic Scaffold Tag



Product Code: ST 12302GY Type: Rigid Plastic Sheet Width x Height (mm): 105 x 210



Product Code: ST 12303W Type: Rigid Plastic Sheet Width x Height (mm): 105 x 210

Scaffold Safety Cap

These scaffold caps protect the users from injuries against scaffold protruding pipe-ends. Simple to fix & compliance to safety requirement. User friendly and resistant to all types of weather.
Malaysia Design Pending 02-00403



Product Code: SF-SC40 Type: Scaffold Safety Cap Width x Height (mm): 100 pcs/box, 600 pcs/carton

USECHH Regulations 2000 (USE AND STANDARDS OF EXPOSURE OF CHEMICALS HAZARDOUS TO HEALTH REGULATIONS 2000) Part XI Regulation 29.3

Ensure employees are aware of the dangers in their working environment and effective method of identifying storage areas.



US 2401

Product Code: US 2401 Type: Self-adhesive Labels Width x Height (mm): 300 x 400
US 2402 Type: Self-adhesive Labels Width x Height (mm): 300 x 400



US 2402



US 2403

Product Code: US 2403 Type: Self-adhesive Labels Width x Height (mm): 300 x 400
US 2404 Type: Self-adhesive Labels Width x Height (mm): 300 x 400



US 2404



US 2405

Product Code: US 2405 Type: Self-adhesive Labels Width x Height (mm): 300 x 400
US 2406 Type: Self-adhesive Labels Width x Height (mm): 300 x 400



US 2406



US 2407

Product Code: US 2407 Type: Self-adhesive Labels Width x Height (mm): 300 x 400
US 2408 Type: Self-adhesive Labels Width x Height (mm): 300 x 400



US 2408



HEAD PROTECTION

GENERAL TECHNICAL INFORMATION



Safety Helmet

Personal protective headwear is a must in any workplace where workers are exposed to the potential hazards of a falling objects or debris.

Proguard range of safety helmets and accessories has been designed and manufactured according to various tough working conditions. You'll find comfort, variety of models and versatility in our unique range of safety helmet & accessories.

All our safety helmets are manufactured & certified accordance to EN397 by British standard of Institute (BSI) & Inspec International, AS/NZS 1801 by SAI Global (Licence No: SMKH20500) and MS183 by Standard & Industrial Research Institute of Malaysia (SIRIM) (Certification No: PP 071002). Our safety helmets are recommended to use with confidence to meet all safety regulation & safety standards.

STANDARDS COMPLIANCE

EN397, AS/NZS1801, MS183 & ANSI Z89.1: Industrial Safety Helmets
EN812: Bump Caps

Each helmet must be indicated a moulded or printed marking, example: Standard number, manufacturer identification or brand, month & year of manufacturer, helmet type & helmet size range. User instruction leaflet must be provided for assembly, usage, cleaning, maintenance, shelf life and storage purposes.

IDENTIFY HAZARDS

- A safety helmet is required in almost every industry where there is a risk of injured by falling object.
- In areas of restricted head space where accidental bumping of the head could be involved, a bump cap should be considered. Bump caps are not a substitute for safety helmets and must not be used to protect the head from falling object.

SHELF LIFE

Generally all safety helmets should be marked with month & year of manufacture. If the helmets are stored in boxes which they are supplied and not experience any environmental extremes, the shelf life is not limited. However, it is not recommended that a helmet should be in use after 5 years from date of manufacturer.

Used head protection gear is generally treated with lack of care; such as, often being thrown, dropped or placed on the rear window shelf of the vehicle. None of these actions are conducive to continued protection performances of the helmet. Proguard recommended users to regularly inspect both helmet shell & harness for sign of wear & tear and to store in a cool and dry place when not in use.

ACCESSORIES

Some helmets have sweatbands, chinstrap or both ready fitted with the helmets. Either can be purchase separately.

Safety helmets can be fitted with a wide range of visors or hearing protection.

Safety Eyewear

Safety eyewear provides eye protection against flying particles, liquids and dust.

Proguard markets a complete line of eye & face protective equipments. These products were created in response to market demand for comfort, design & fashionable and also manufactured in accordance with strict international standards.

This comprehensive range includes protective eyewear, goggles and faceshields. These products meet most safety needs and expectations in the workplace. **Stylist** with a cutting edge, **Comfort** for today demands & **Safety** for all round protection.

STANDARDS COMPLIANCE

ANSI Z87.1 or EN166
Applicable to all type is individual eye and face protection which protects from hazards likely to damage the eye and face.

Basic Symbol Used by ANSI Z87.1

Z87: Basic Impact Protector
Z87+: High Impact Protector
S: Special Purpose Lens

Basic Symbol Used for EN166

- 1: Optical Class 1 (Best Quality)
- A: High Energy Impact
- B: Medium Energy Impact
- F: Low Energy Impact
- S: Increased Robustness
- T: Extreme Temperatures
- 3: Liquids
- 4: Large Dust Particles
- 5: Gas and Fine Dust Particles
- 8: Short Circuit Electric Arc
- 9: Molten Metal and Hot Solid

Type of Eye Protector

Safety Spectacles

Spectacles are eye protector designed to shield the wearer's eye from certain hazards. Spectacles may in many cases to be use alone. When faceshields are required, safety eyewear or goggle is recommended to be worn in conjunction with the faceshield.

Safety Goggle

Goggles are eye protector intended to fit the face immediately surrounding the eyes in order to shield the eyes from variety of hazards. While goggles may used alone, they may be also used in conjunction with other protectors.

Safety Faceshield

Faceshields are part of eye protector designed to shield the wear's face or portions there of, in addition to the eyes from certain hazards. Comfortable to use for long period.

CARE & MAINTENANCE

Both employee and employer have a responsibility to keep all eye or face protection in good condition. Cleaning and maintenance information are provided in the user instruction.



HEARING PROTECTION

GENERAL TECHNICAL INFORMATION



Earmuffs

Simply a traditional method of ear protection. Today's ranges of earmuff cope with a very wide spectrum of industrial hazards. It is important to study the attenuation characteristic of each model as they do vary in performance across the range of sound frequency.

Helmet Mounted Earmuffs

These all-in-one head & hearing protection are popular among safety officers. Today's models are styled to be sensibly "parked" when not in use.

Earplugs

Can be worn conveniently with all other PPE equipments. Easy to use with attenuation provided often exceeding that of an earmuff. Both disposable & re-useable earplugs provided excellent protection with long term comfort.

STANDARDS

Earmuffs and earplugs are tested to the relevant European standards or American Standard

EN352-1 Earmuffs
EN352-2 Earplugs
EN352-3 Helmet Mounted Earmuff
ANSI S3.19 Measurement of Real-Ear Hearing Protector Attenuation and Physical Attenuation of Ear-Muffs.

SNR (Single Number Rating)

SNR is a single-number rating which is calculated in accordance with ISO 4869 2.2(1992). "Estimation of effective A-weighted Sound Pressure Levels When Hearing Protectors are Worn". Normally used by European Standard.

NRR (Noise Reduction Rating)

NRR is a single number rating which is required by US law to be shown on the label of each hearing protection sold in United States.

Different Between SNR and NRR

The main difference is the SNR is calculated using a single standard deviation while NRR formula deducts two standard deviations.

Disposable Particulate Respirator

These disposable particulate respirators are approved for use against solid and liquid aerosols according to EN149:2001.

P1 respirator can provide protection against solid and liquid aerosols containing the following material such as: calcium carbonate, china clay, cement, cellulose, sulfur, cotton, flour, ferrous metal, vegetable oils and soft wood.

P2 respirator can provide protection against solid and liquid aerosols containing the following material such as: calcium carbonate, china clay, ferrous metal, hardwood, glass fibers, plastic, vegetable & mineral oils, quartz, copper, aluminium, bacteria, fungi & mycobacterium tuberculosis (T.B)

P3 respirator can provide protection against solid and liquid aerosols containing the following material such as: calcium carbonate, china clay, ferrous metal, sulfur, carbon, glass fibers, plastic, vegetable & mineral oils, quartz, copper, aluminium, bacteria, fungi & mycobacterium tuberculosis (T.B), chromium, manganese, nickel, platinum, strychnine, metal dust, smoke, viruses and enzymes.

Respiratory Half Masks & Full face Mask

These respiratory masks are approved for use against the respiratory attack of dust, mist, aerosol, fumes & gases accordance to EN140 & EN136.

To choose the correct respiratory apparatus or system (half mask, or full face mask fitted with either one or two filter cartridges).

- Identify the toxic product
- Identify the type of risk such as dust, mist, aerosol, fumes & gases
- Determine what types for cartridges to use. Example: A, B, E, K, AX, P3

Types of Filter Cartridges

Filter use chart			
Colour Code	Filter Type	Application	Standard
	A	Organic gases and vapour (boiling point > 65°C)	EN141
	B	Inorganic gases and vapour (not CO)	EN141
	E	Acid gases and vapour	EN141
	K	Ammonia	EN141
	AX	Organic gases and vapour (boiling point < 65°C)	EN371
	Hg-P3	Mercury Vapours	EN141
	P3	Hepa, Dust, Fumes & Radioactive	EN141



RESPIRATOR PROTECTION

GENERAL TECHNICAL INFORMATION



Alphabetical List of industrial gases and toxic substances

This overview of industrial gases and toxic substances guides you in selecting the appropriate filter type. Before using respiratory protection always read the instructions for use.

Limitation of use:

Filters for respiratory protection may be used everywhere, expect for some inherent limitation e.g. Confined Spaces or Containers. Principally the following conditions must be known:

- Type, property and composition of contaminant
- Oxygen content of the inhalation air must be sufficient i.e. >17%
- Local restrictions should be observed

For all gases and vapours which may be present in combination with particles (dust, smoke, mist, spray) a combination filter (gases & particles) must be used.

The recommendations below are based on pure substances. With mixtures, by-products or decomposition products the impurities must be taken into account. For compounds with a boiling point below 65°C an AX filter must be used.

For information on substances not listed please contact us.

Substance	Formula	Filter Type	Colour
1, 1, 2, 2-Tetrachloroethane	CHCl2CHCl2	A	Brown
1, 2-Dibromoethane	CH2BrCH2Br	A	Brown
1, 2-Dichloroethane	CH2ClCH2Cl	A	Brown
1, 2-Dichloroethylene	CHClCHCl	AX	Brown
1, 2-Dichloropropane	C3H6Cl2	A	Brown
1, 4-Dioxane	C4H8O2	A	Brown
2 Amino-Ethanol	CH2OHCH2NH2	A	Brown
Acetaldehyde	CH3CHO	AX	Brown
Acetic Acid	CH3COOH	E	Yellow
Acetone	CH3COCH3	AX	Brown
Acetonecyanhydrin	CH3C(OH)(CN)CH3	A - P3	Brown - White
Acetonitrile	CH3CN	A	Brown
Acidic Gases		E	Yellow
Acids (fuming concentrated)		E - P2	Yellow - White
Acrolein (2-Propenal)	CH2CHCHO	AX	Brown
Acrylic Acid-esters	CH2CHCOOR	A	Brown
Acrylonitrile	CH2CHCH2Cl	AX	Brown
Alcohols	R'OH	A	Brown
Aldehydes	R'CHO	A or AX	Brown
Allylchloride	CH2CHCH2Cl	AX	Brown
Ammonia	NH3	K	Green
Aniline	C6H5NH2	A - P3	Brown - White
Aqueous Ammonia	NH3H2O	K	Green
Arsenic Trioxide	As2O3	P3	White
Arsine	AsH3	B - P3	Grey
Benzene	C6H6	A	Brown
Benzyl Bromide	C6H5CH2Br	A - P2	Brown - White
Beryllium	Be	P3	White
Bromine	Br2	B - P3	Grey - White
Bromoform	CHBr3	A	Brown
Bromomethane	CH3Br	AX	Brown
Butanone	CH3COC2H5	A	Brown
Butyl Acetate	CH3COOC4H9	A	Brown
Butyl Acrylate	CH2CHCOOC4H9	A	Brown
Butyl Alcohols	C4H9OH	A	Brown

Substance	Formula	Filter Type	Colour
Carbon Black	C	P2	White
Carbon Dioxide	CO2	*	
Carbon Disulphide	CS2	b	Grey
Carbon Monoxide	CO	CO	Black
Carbon Oxysulphide	COS	B	Grey
Carbon Tetrachloride	CCl4	A	Brown
Caustic Soda	NaOH	P2	White
Chlorine	Cl2	B - P3	Grey - White
Chlorine Dioxide	ClO2	B	Grey
Chlorobromomethane	CH2ClBr	AX	Brown
Chloroform	CHCl3	AX	Brown
Chloromethane	CH3Cl	*	
Chloroprene	CH2C(O)CHCH2	AX	Brown
Chlorosulfonic Acid	ClSO3H	B - P2	Grey - White
Chromium Oxide	Cr2O3, CrO3	P3	White
Cresols		A	Brown
Cyanogen Chloride	CICN	B	Grey
Cyclohexanone	C6H10O	A	Brown
Cyclohexane	C6H12	A	Brown
DD Products		A - P2	Brown - White
DDT Dust		P3	White
Dichloromethane	CH2Cl2	AX	Brown
Diesel Fuel		A	Brown
Dimethylformamide (DMF)	HCON(CH3)2	A	Brown
Diocetonel Alcohol	(CH3)2C(OH)CH2COCH3	A	Brown
Dust		P2/P3	White
Epichlorhydrin	C3H5OCl	A - P3	Brown - White
Esters	R-COOR	A or AX	Brown
Ethanolamine	CH2OHCH2NH2	A	Brown
Ethers	ROR	A or AX	Brown
Ethyl Acetate	CH3COOC2H5	A	Brown
Ethyl Alcohol (Ethanol)	C2H5OH	A	Brown
Ethyl Benzene	C6H5CH2CH3	A	Brown
Ethyl Formate	HCOOC2H5	AX	Brown
Ethylene Chloride	CH2ClCH2Cl	A	Brown



RESPIRATOR PROTECTION

GENERAL TECHNICAL INFORMATION



Substance	Formula	Filter Type	Colour
Ethylene Dichloride	CH2ClCH2Cl	A	Brown
Ethylene Oxide (T-Gas)	C2H4O	AX	Brown
Formaldehyde	HCHO	B-P3	Grey - White
Formic Acid	HCOOH	E	Yellow
Furfuryl Alcohol	C5H4O2	A	Brown
Gasoline		A	Brown
Halogenated Hydrocarbons	R-Hal	A or AX	Brown
Halogens	Hal2	B-P3	Grey
Hexachlorocyclohexane	C6H6Cl6	A-P3	Brown - White
Hydrazine	N2H4	K-P3	Green - White
Hydrocarbons	R-H	A	Brown
Hydrochlorid Acid	HCl/H2O	E	Yellow
Hydrogen Bromide	HBr	E - P2	Yellow - White
Hydrogen Chloride	HCl	E - P2	Yellow - White
Hydrogen Cyanide	HCN	B	Grey
Hydrogen Fluoride	HF/H2O	E	Yellow
Hydrogen Halogenides	HF, HCl, HBr, HJ	E - P2	Yellow - White
Hydrogen Selenide	H2Se	B - P2	Grey - White
Hydrogen Sulphide	H2S	B	Grey
Insecticide (Organic)		A - P2	Brown - White
Iodine	I2	B - P2	Grey - White
Iodine (Radioactive)	I2	Reactor P3	Orange - White
Iodomethane	CH3I	AX	Brown
Iodomethane (Radioactive)	CH3I	Reactor P3	Orange - White
Iron- Pentacarbonyl	Fe(CO)5	CO - P3	Black - White
Isocyanates (organic)	R-NCO	B-P2	Grey - White
Isopropyl Alcohol	CH3CH(OH)CH3	A	Brown
Ketenes	R-CH2 - O3	*	
ketones	R-CO-R	A	Brown
Lead Fumes	Pb	P2	White
Maleic Anhydride	C4H2O3	A - P2	Brown - White
Mercaptans	R-SH	B	Grey
Mercury Compounds		Hg - P3	Red - White
Mercury Vapour	Hg	Hg - P3	Red - White
Metal Fumes		P2, P3	White
Methanol	CH3OH	AX	Brown
Methyl Bromide	CH2Br	AX	Brown
Methyl Chloride	CH3Cl	*	
Methyl Chloroform	CH3CCl3	A	Brown
Methyl Ethyl Ketone (MEK)	CH3COC2H5	A	Brown
Methyl Isobutyl Ketone (MIBK)	CH3COC4H9	A	Brown
Methylene Chloride	CH2Cl2	AX	Brown
Nickel Tetracarbonyl	Ni(CO)4	CO - P3	Black - White
Nitric Acid	HNO3/H2O	NO	Blue
Nitro Compounds (Organic)	R-NO2	A	Brown

Substance	Formula	Filter Type	Colour
Nitrogen Oxides	NO, NO2, N2O5	NO	Blue
Nitrous Fumes	NO, NO2, N2O5, HNO2, HNO3	NO	Blue
Organic Nitro Compounds	R-NO2	A	Brown
Organic Vapours- Solvent		A, AX	Brown
Ozone	O3	CO	Black
Paint Sprays/Vapours		A - P2	Brown - White
Pentachloroethane	CHCl2CCL2CCI3	A	Brown
Perchloroethylene	CCl2CCI2	A	Brown
Pesticides		A - P2	Brown - White
Petrol		A	Brown
Phenols		A	Brown
Phenylhydrazine	C6H5NHNH2	A	Brown
Phosgene	COCl2	B	Grey
Phosphine	PH3	B	Grey
Phosphorous Trichloride	PCl3	B - P2	Grey - White
Polyacrylates		A - P2	Brown - White
Potassium Cyanide (Dust)	KCN	B - P3	Grey - White
Propanol	CH3CH2CH2OH	A	Brown
Pyridine	C5H5N	A	Brown
Quartz	SiO2	P2	White
Sodium Hydroxide	NaOH	P2	White
Solvents		A	Brown
Stibine	SbH3	B - P3	Grey - White
Styrene	C6H5CHCH2	A	Brown
Sulfuryl Chloride	SO2Cl2	B	Grey
Sulphur Compounds (Burning)	SO2	E - P2	Yellow - White
Sulphur Dioxide	SO2	E	Yellow
Sulphur Monochloride	S2Cl2	B - P2	Grey - White
Sulphur Trioxide	SO3	P2	White
Sulphuric Acid	H2SO4	B - P2	Grey - White
Tetrachloroethylene	CCl2CCI2	A	Brown
Tetrachloromethane	CCl4	A	Brown
Tetrahydrofuran	C4H8O	A	Brown
T-Gas (Ethylene Oxide)	(C2H4O)	AX	Brown
Toluene	C6H5 CH3	A	Brown
Tribromomethane	CHBr3	A	Brown
Turpentine		A	Brown
Vanadium Pentoxide (Dust/Fumes)	V2O5	P2	White
Vinyl Acetate	C4H6O2	A	Brown
Vinyl Chloride	CH2CCI2	AX	Brown
Vinyltoluene	CH3C6H4CHCH2	A	Brown
Xylene	CH3C6H4CH3	A	Brown
Zinc Oxide	ZnO	P2	White
Zyklon (HCN with irritant)		B	Grey



HAND PROTECTION

GENERAL TECHNICAL INFORMATION



Chemical Resistance Table

	Nitrile	PVC Vinyl	Neoprene	Natural latex
20% nitric acid	•••	•	•••	•••
30% and 5% hydrochloric acid	•••	•	•••	•••
30% formaldehyde	•••	•••	•••	•••
30% hydrofluoric acid	•••	•••	•••	•••
50% acetic anhydride	•••	•••	•••	•••
85% lactic acid	•••	•••	•••	•
85% triethanolamine	•••	•••	•••	•••
90% formic acid	•	•	•••	•••
Acetaldehyde	•	•	•••	•••
Acetone	•	•	•••	•••
Alcoholic beverages	•••	•••	•••	•••
Ammonium acetate	•••	•••	•••	•••
Ammonium carbonate	•••	•••	•••	•••
Ammonium chloride	•••	•••	•••	•••
Amyl acetate	•••	•	•••	•••
Amyl alcohol	•••	•••	•••	•••
Aniline	•	•	•••	•••
Animal fats	•••	•••	•••	•
Asphalt	•	•	•••	•••
Beet-root	•••	•••	•••	•••
Benzaldehyde	•	•	•••	•••
Benzene	•	•	•••	•••
Benzyl alcohol	•••	•••	•••	•
Bichromate of potash	•••	•••	•••	•
Bleach	•••	•••	•••	•••
Borax	•••	•••	•••	•••
Brake oils (lockhead)	•••	•	•••	•
Bromides	•••	•••	•••	•••
Butter	•••	•	•••	•••
Butyl acetate	•	•	•	•
Butyl alcohol (or n-butanol)	•••	•••	•••	•••
Calcium acetate	•••	•••	•••	•••
Calcium chloride	•••	•••	•••	•••
Calcium fluophosphate	•••	•••	•••	•••
Calcium hydrate	•••	•••	•••	•••
Calcium nitrate	•••	•••	•••	•••
Carbolic acid	•••	•	•••	•••
Carbon tetrachloride	•••	•	•	•
Castor oil	•••	•••	•••	•••
Chlorinated lime	•••	•••	•••	•••
Chlorine	•••	•••	•••	•••
Chloroacetone	•••	•••	•••	•••
Chloroform	•••	•••	•	•••
Chromic acid	•••	•••	•••	•••
Citric acid	•••	•••	•••	•••
Concentrated ammonia	•••	•••	•••	•••
Concentrated boric acid	•••	•••	•••	•••
Concentrated laundry potash	•••	•••	•••	•••
Concentrated laundry soda	•	•	•••	•••
Concentrated sulphuric acid	•••	•••	•••	•••
Creosote	•••	•••	•••	•
Cresol	•••	•••	•••	•••
Crystallisable acetic acid	•••	•••	•••	•••
Cutting oils	•••	•••	•••	•••
Cyclohexane	•••	•••	•••	•••
Cyclohexanol	•••	•••	•••	•••
Cyclohexanon	•••	•••	•••	•••
Dead lime	•••	•••	•••	•••
Diacetone Alcohol	•••	•	•••	•••
Dibutyl ether	•••	•	•	•••
Dibutyl phtalate	•••	•	•	•••
Diehanolamine	•••	•••	•••	•••
Diesel oils	•••	•	•	•••
Diluted sulphuric acid (battery)	•••	•••	•••	•••
Diocylphtalate	•••	•••	•••	•••
Dyes (hair dyes)	•••	•••	•••	•••
Ethyl acetate	•	•	•	•
Ethyl alcohol (or ethanol)	•••	•••	•••	•••
Ethylamine	•••	•	•	•
Ethylamine	•••	•••	•••	•
Ethylene dichloride	•	•	•	•
Ethylene glycol	•••	•••	•••	•••
Fertilisers	•••	•••	•••	•••
Fish and shellfish	•••	•••	•••	•
Fixing agents	•••	•••	•••	•••
Fluorides	•••	•••	•••	•••
Formaldehyde	•••	•••	•••	•••
Fuel oil	•••	•	•	•••
Fuels	•••	•	•	•••
Furol (furfural or furaldehyde)	•••	•	•	•••
Gas-oil	•••	•	•	•••
Gasoline	•••	•	•	•••
Glycerin	•••	•••	•••	•••
Glycerophthalic paint	•••	•	•	•••
Glycols	•••	•••	•••	•••
Hair bleaching agents	•••	•••	•••	•••
Hair-curling products	•••	•••	•••	•••
Hexane	•••	•	•	•••
Household detergents	•••	•	•	•••
Hydraulic fluids (esters)	•••	•••	•••	•••
Hydraulic oils (petrol)	•••	•	•	•••
Hydrobromic acid	•	•	•	•••
Hydrogen peroxide	•••	•••	•••	•
Isobutyl alcohol	•••	•••	•••	•••
Isobutyl ketone	•••	•••	•••	•••
Kerosene	•••	•	•	•••
Lard oil	•••	•	•	•••
Linseed oil	•••	•	•	•••
Lubricating oils	•••	•	•	•••
Magnesia	•••	•••	•••	•••
Methyl acetate	•	•	•••	•••
Methyl alcohol (or methanol)	•••	•••	•••	•••
Methyl ethyl ketone	•	•	•••	•••
Methyl isobutyl ketone	•	•	•••	•••
Methyl salicylate	•••	•••	•••	•••
Methylamine	•••	•••	•••	•••
Methylaniline	•••	•••	•••	•
Methylcyclopentane	•••	•	•	•••
Methyleme chloride	•	•	•	•••
Methylformiate	•	•	•	•
Milk and dairy products	•••	•••	•••	•
Mineral greases	•••	•••	•	•••
Mono ethanol amine	•••	•••	•••	•••
Naphta	•••	•	•	•••
Naphtalene	•••	•	•	•••
N-butylamine	•••	•••	•••	•••
Nickel Chloride	•••	•••	•••	•••
Nitrate of ammonium	•••	•••	•••	•••
Nitrate of potassium	•••	•••	•••	•••
Nitrobenzene	•••	•	•	•••
Nitrohydrochloric acid	•	•	•	•••
Nitropropane	•	•	•	•••
Non-alcoholic beverages	•••	•••	•••	•••
Octyl alcohol	•••	•••	•••	•••
Oleic acid	•••	•	•	•
Olive oil	•••	•	•	•
Oxalic acid	•••	•••	•••	•••
Paraffin oil	•••	•	•	•••
Peanut oil	•••	•	•	•••
Perfumes and essences	•••	•	•	•••
Petroleum ether	•••	•	•	•••
Petroleum products	•••	•	•	•••
Petroleum spirit	•••	•	•	•••
Phenyl chloride	•	•	•	•
Phosphates of calcium	•••	•••	•••	•••
Phosphoric acid	•••	•••	•••	•••
Polyester resins	•••	•	•	•••
Potash flakes	•••	•••	•••	•••
Potassium acetate	•••	•••	•••	•••
Potassium bicarbonate	•••	•••	•••	•••
Potassium carbonate	•••	•••	•••	•••
Potassium chloride	•••	•••	•••	•••
Potassium cyanide	•••	•••	•••	•••
Potassium manganate	•••	•••	•••	•••
Potassium phosphates	•••	•••	•••	•••
Potassium sulphate	•••	•••	•••	•••
Poultry	•••	•••	•••	•
Propylene dichloride	•	•	•	•
Quick lime	•••	•••	•••	•••
Shampoos	•••	•••	•••	•••
Silicates	•••	•••	•••	•••
Soda flakes	•	•	•	•••
Sodium bicarbonate	•••	•••	•••	•••
Sodium bisulphite	•••	•••	•••	•••
Sodium carbonate	•••	•••	•••	•••
Sodium chloride	•••	•••	•••	•••
Sodium chlorite	•••	•••	•••	•••
Sodium nitrate	•••	•••	•••	•••
Sodium phosphates	•••	•••	•••	•••
Sodium sulphate	•••	•••	•••	•••
Soybean oil	•••	•••	•••	•••
Stannic chloride	•••	•••	•••	•
Stearic acid	•••	•••	•••	•••
Styrene	•	•	•	•
Sulphites, bisulphites, hyposulphites	•••	•••	•••	•••
Sulphuric ether (pharmacy)	•••	•••	•••	•••
Tartaric acid	•••	•••	•••	•••
Tetrachloroethylene	•••	•	•	•••
THF = tetrahydrofuran	•	•	•	•
Toluene	•••	•	•	•
Tributyl phosphate	•••	•	•	•
Trichlorethylene	•••	•	•	•
Tricresyl phosphate	•••	•	•	•••
Trinitrobenzene	•••	•	•	•
Trinitrotoluol	•••	•	•	•
Triphenyl phosphate	•••	•	•	•
Turbine oils	•••	•	•	•••
Turnipseed oil	•••	•	•	•••
Turpentine	•••	•	•	•••
Vinegar and condiments	•••	•••	•••	•••
Washing powders	•••	•••	•••	•••
Water paint	•••	•••	•••	•••
Weed killers	•••	•••	•••	•••
Wood turpentine	•••	•	•	•••
Xylene	•••	•	•	•••
Xylophene	•••	•	•	•••
Zinc sulphate	•••	•••	•••	•••

••• Very good •• Good • Average □ Not recommended

This table provides only general information. Be careful! Glove resistance is influenced by other factors such as temperature, chemical product concentration, thickness, immersion time, and others. For specific use conditions, we recommend testing the glove prior to use.



HAND PROTECTION

CHOOSING THE CORRECT GLOVES FOR JOB - EN Standards



EN420 General Requirements for Protective Gloves

EN420 is the underlying general standard to which all protective gloves must comply it relates specifically to size, dexterity and the inert nature of the fabric that the glove has been "constructed" from i.e. the material's pH level and levels of substances such as Chrome VI, which is used in the curing of leather, and gives many gloves their "chrome" colouring.

EN388 Mechanical Hazards

The term Mechanical Hazard does not, as one might assume, have any connection to machinery, it is in fact a collective term for a range of four specific hazards that can be encountered in the handling of sharp or rough materials such as timber, bricks, steel strapping and sheet glass etc.



- a. Abrasion resistance
- b. Cut (by slicing) resistance
- c. Tear resistance
- d. Puncture resistance

Performance level 1-4
Performance level 1-5
Performance level 1-4
Performance level 1-4

Performance for these tests are ranked 1 as lowest and 5 the highest attainable. If the symbol X appears it indicates that the glove was not tested against this hazard. A rating of 0 is below the minimum performance required to attain level 1.

Please Note - On certain gloves two further pictograms may be present; both come under EN388, these are:



EN388 Impact Cut

Protection from Impact Cut is tested for by dropping a metal blade weighing 1050g onto the glove from a height of 150mm. Performance for this test is rated as either **Pass or Fail**



EN388 Static Electricity

The Static Electricity test indicates a volume resistivity threshold between 10⁶ and 10⁹ Ω cm. A glove meeting this criterion can reduce the risk of electrostatic discharges i.e. static sparks, a property useful in clean room areas and potentially flammable atmospheres. Performance for this test is rated as either **Pass or Fail**

EN374-2 Bacteriological Contamination Hazards

The Bacteriological Contamination standard relates to the resistance to Penetration of a glove by micro-organisms. This is proven by the glove's water tightness i.e. by an air leakage test. Performance for this test is rated as either **Pass and Fail**

EN374-3 Chemical Hazards

EN374-3 deals with a glove's resistance to chemical hazards and is measured in terms of Permeation i.e. the time it takes for a specified chemical agent to break through the glove. Performance for this test is rated by an index of 1 to 6, indicating the time taken for a molecule of the chemical to pass through the glove.

Performance Level	1	2	3	4	5	6
Breakthrough Time (min)	>10	>30	>60	>120	>240	>480

NOTE: Given the vast number of chemicals that are commercially available, it is vital that the correct gloves are chosen. Please contact PROGUARD sales team if you require advice in selecting a glove for a specified chemical hazard.

EN407 Thermal Hazards

The EN407 standard deals with the protection afforded to the wearer by a glove against specific thermal hazards. The hazards are categorised from a-f and the performance levels from 1-4



- a. Flammability resistance (burning behaviour)
- b. Contact heat resistance
- c. Convective heat resistance
- d. Radiant heat resistance
- e. Resistance to small splashes of molten metal
- f. Resistance to large splashes of molten metal

Performance level 1-4
Performance level 1-4
Performance level 1-4
Performance level 1-4
Performance level 1-4
Performance level 1-4

EN511 Cold Hazards

EN511 deals with the protection afforded against various cold hazards, denoted by the letters a-c. The performance levels attained against the hazards 'a' & 'b' are rated 1-3, with resistance to water penetration, hazard 'c' being rated at 1 if the glove is impermeable to water for at least 30 minutes.



- a. Convection cold resistance
- b. Cold contact resistance
- c. Water permeability resistance

EN421 Ionizing Radioactive Contamination



The standard EN421 is concerned with protective gloves for ionizing radiation including contamination and direct exposure to radiation. The gloves must undergo a water tightness test as well as specific tests depending on the glove's use. The inclusion of hte pictogram symbol indicates the product has passed the test.

EN60903 Insulating Protective Gloves for Working with Electricity

The standard for Electrically Insulating Gloves covers the testing criteria for the different Classes of gloves, and also sets out details for their storage, handling and on going care. The pictogram for this standard appears on the gloves themselves. It details the Class of the glove (which in itself indicates the maximum working voltage for the gloves), the Manufacturer, the Date of Manufacture in terms of the month and the year, the size of the glove, and also the manufacturing batch number e.g. LOT number. Below the lot number, a number of boxes are also printed onto the gloves, allowing the user to insert details such as the first date of use, or the name of the user etc, to allow tracking gloves through their life.



Class
Manufacturer
Month/Size/Year

LOTxxxx

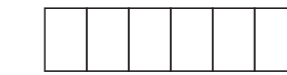

Working AC Voltages for Electrically Insulating Gloves to EN60903

Tested	Tension of use	Class
2500V	500V	00
5000V	1000V	0
10000V	7500V	1
20000V	17000V	2
30000V	26500V	3

Notice: be advise that wearing protective gloves for extended periods of times, particularly in hot/ or humid weather, will result in perspiration. Therefore, it is advised to take the gloves off from time to time to let your hands breathe in open air and change dirty or worn gloves. Never expose oneself to a risk with bare hands. The user is also advised to wash his hands with clean water, possible with neutral soap after using the gloves. Put the gloves on clean dry hands.

EN659:2003 Protection Gloves for Fire-Fighters



EN659:2003 is the latest version of the standard against which fire-fighters' gloves are tested and approved. The standard is complex in that it requires the gloves to have passed various performance levels under other EN standards as well as its own highly specific tests, such as Annex A which requires 'no melt, drip or ignition' of the glove's lining material and Para 3.13 which specifies that the gloves must be able to be removed in 3 seconds or less.

The other EN standards for which the gloves must meet specific performance levels include EN388 Mechanical Hazards, EN407 Thermal Hazards - Burning Behaviour, *EN367 Convective Heat, *EN366 Radiant Heat, *EN



HIGH VISIBILITY CLOTHING

GENERAL TECHNICAL INFORMATION



EN471 Garments Classification

▶ Garment types are grouped into 3 classes based on the conspicuity provided. With the classes dictating the minimum quantities of background and retroreflective materials to be used.

CLASS 2. Intermediate Protection Level

▶ Bands of retroreflective material shall not be less than 50mm wide. Minimum background material 0.5m². Minimum retroreflective material 0.13m².

CLASS 1. Lowest Protection Level

▶ Where advanced visibility is an advantage, but for minimal risk/off road purposes only. Bands of retroreflective material shall not be less than 50mm wide. Minimum background material 0.14m². Minimum retroreflective material 0.10m².

CLASS 3. Highest Protection Level

▶ Bands of retroreflective material shall not be less than 50mm wide. Minimum background material 0.80m². Minimum retroreflective material 0.2m².

Material	Class 1	Class 2	Class 3
Background garment (Fluorescent)	0.14m ²	0.50m ²	0.80m ²
Retroreflective band	0.10m ²	0.13m ²	0.20m ²



Typical Class 3 Coverall & Jackets

TYPICAL CLASS STYLE



Typical Class 2 Waistcoat



SAFETY SHOE & BOOTS

GENERAL TECHNICAL INFORMATION

▶ Both Malaysia Standard & European Standard specifies by reference to MS1599 & ISO EN 20345 respectively with basic & additional (optional) requirements for safety footwear for professional use.

This safety footwear's incorporating with safety toe caps are designed to withstand a maximum impact of 200 joules.

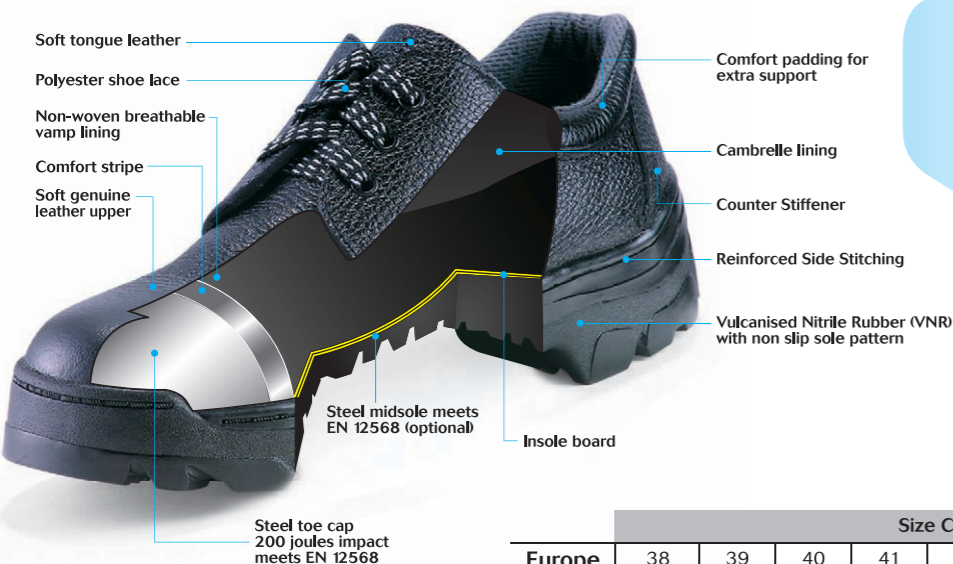

Safety Specification

- OIL RESISTANT
- RESISTANT
- ENERGY ABSORPTION
- STEEL TOE CAP
- REINFORCED SIDE STITCHING
- PENETRATION RESISTANT STEEL MIDSOLE
- CHEMICAL RESISTANT
- HEAT INSULATION

	Size Comparison Table									
Europe	38	39	40	41	42	43	44	45	46	47
UK	4	5	6	7	8	9	10	11	12	13
US	5	6	7	8	9	10	11	12	13	14



EMERGENCY EYEWASH & SHOWERS

GENERAL TECHNICAL INFORMATION



ANSI Z358.1

The OSHA regulation regarding emergency equipment is quite vague, in that it does not define what constitutes "suitable facilities" for drenching the eyes or body in order to provide additional guidance to employers, the American National Standards Institute (ANSI) has promulgated a voluntary standard covering emergency eye wash and shower equipment. This standard- ANSI Z358.1- is intended to serve as a guideline for the proper design, performance, installation, use and maintenance of emergency equipment.

GENERAL CONSIDERATIONS

ANSI Z358.1-2004 contains provisions regarding the design, performance, installation, use and maintenance of emergency equipment (showers eyes washes, drench hoses, etc). In addition to these provisions there are some general considerations may not necessarily be part of the standard but we believe that they should be addressed when considering emergency equipment. These include the following:

FIRST AID DEVICES

Emergency eyewash and shower units are designed to deliver water to rinse contaminants from a user's eyes, face or body. As such, they are a form of first aid equipment to be used in the event of an accident. However, they are not a substitute for primary protective devices (including eye and face protection and protective clothing) or for safe procedures for handling hazardous materials.

EMERGENCY RESPONSE

Simply installing emergency equipment is not a sufficient means of assuring worker safety. Employees must be trained in the location of emergency equipment and in its proper use. Emergency equipment must be regularly maintained (including weekly activation of the equipment) to assure that it is in working order and inspected at least annually for compliance with the standard. Most importantly, employers should develop a response plan to be used in the event that an accident does occur. The focus of the response plan should be to provide assistance to the injured worker as quickly as possible. We offer a variety of alarm systems, which may be installed in conjunction with our emergency equipment. They serve to alert personnel and summon assistance if an eyewash or shower is activated. WE RECOMMEND INSTALLING AN ALARM UNIT WITH ANY EMERGENCY EYE WASH OR SHOWER UNIT.

LOCATION OF EMERGENCY EQUIPMENT

In general, the ANSI standard provides that emergency equipment be installed within to seconds walking time from the location of a hazard. The equipment must be installed on the same level as the hazard. (i.e. accessing the equipment should not require going up or down stairs or ramps.) The path of travel from the hazard to the equipment should be free of obstructions and as straight as possible.

However, there are certain circumstances where these guidelines may not be adequate. For example, where workers are handling particularly strong acids or caustic or other materials where the consequences of a spill would be very serious, emergency equipment should be installed immediately adjacent to the hazard.

Laboratory environments may also require special consideration. It is common in many laboratory buildings to install emergency equipment in a corridor or hallway outside of the lab room. This may satisfy the provisions of the standard but still not provide workers with immediate access to emergency equipment in these cases, we recommend installing combination eye wash/ drench hose units at lab sinks. These units are highly accessible and versatile. They provide immediate protection for the eyes, face or body when a spill involves a relatively small amount of hazardous material.

WATER TEMPERATURE

The 2004 version of the standard states that the water temperature delivered by emergency equipment should be "tepid" (i.e. moderately warm or lukewarm). However, where it is possible that a chemical reaction might be accelerated by warm water, a medical professional should be consulted to determine what the optimum water temperature would be.

The delivery of tepid water to emergency equipment may raise complicated engineering issues. At a minimum, it generally involves providing both hot and cold water to the unit, and then installing a blending valve to mix the water to the desired temperature. Water Saver offers a variety of mixing valves to blend and temper water. Please contact our office for further information.

DISPOSAL OF WATER

The standard does not include any provisions regarding the disposal of wastewater. However, designers must give consideration to where wastewater will go. In particular, care must be taken that wastewater not create a hazard (i.e. by creating a pool in which someone might slip) or freeze.

Generally, Water Saver eye wash, eye/face wash and safety station units are designed with waste connections for connection to drain piping. **WE RECOMMEND THAT EMERGENCY EYE WASH AND SHOWER UNITS BE CONNECTED TO DRAIN PIPING. FOR EMERGENCY SHOWERS AND FOR OTHER UNITS WITHOUT WASTE CONNECTIONS, FLOOR DRAINS SHOULD BE PROVIDED.** After an emergency eyewash or shower has been used the wastewater may contain hazardous materials that cannot or should not be introduced into a sanitary sewer. It may be necessary to connect the drain piping from the emergency equipment or floor drain to the buildings acid waste disposal system or to a neutralizing tank.



EUROPEAN STANDARDS

THE EUROPEAN STANDARDS FOR FALL PROTECTION



EN Standard	Description	Component
EN 341	Personal Protection Equipment against falls from a height - Descender devices	
EN 353-1	PPE against falls from a height - Part 1: Guided type fall arresters including a rigid anchor line	
EN 353-2	PPE against falls from a height - Part 2: Guided type fall arresters including a flexible anchor line	
EN 354	PPE against falls from a height - Lanyards	
EN 355	PPE against falls from a height - Energy absorbers	
EN 358	PPE for work positioning and prevention of falls from a height - Belts for work positioning and restraint and work positioning lanyards <i>Warning! Do not use for fall arrest purposes</i>	
EN 360	PPE against falls from a height - Retractable type fall arresters	
EN 361	PPE against falls from a height - Full body harnesses Letter "A" for Arrest is attached on each harness.	
EN 362	Personal equipment against falls from a height - Connectors	
EN 363	Personal equipment against falls from a height - Fall arrest systems	
EN 364	Personal equipment against falls from a height - Test methods	
EN 365	Personal equipment against falls from a height - General requirement for instructions for use and for marking	
EN 795	Protection against falls from a height - Anchor devices - Requirements and testing	
EN 813	PPE for prevention of falls from a height - Sit harnesses <i>Warning! Do not use for fall arrest purposes</i>	
EN 1868	PPE against falls from a height - List of equivalent terms	



PERSONAL FALL PROTECTION SYSTEMS

DESCRIPTION OF PERSONAL FALL PROTECTION SYSTEMS



4 individual personal fall protection systems

There are four main personal fall protection systems that apply when working at height. The systems have differences in function and it is of importance to know the differences and choose the correct safety system for the work to be done.

Selection Guide

The ProGuard Safety Professional line included products and systems for most fall protection applications. To help determine which one is right for your needs, look for below symbols throughout the catalog.

Symbol	Description	Symbol	Description
	<p>FALL ARREST SYSTEM</p> <p>An assembly of components or sub-systems used to arrest a person in a fall from a working height. As a general rule. It is recommended that a fall arrest system be used at working heights from 2m and above whenever there is a risk of fall. All fall arrest systems has a energy absorber included in the system which will bring down the forces during a fall to below 6kN. Always avoid dangerous swing falls by working directly below the anchor point. Always check your minimum free clearance distance below your feet as stated in user manual for component. Fall arrest systems are specified in standard EN 363.</p> <p>This system consists of: (see "Guide for personal fall protection systems" for more)</p> <p>A) Anchor point - Structure anchorage with known strength Min. 15kN. Ex. I-beam or Anchor device as specified in standard EN 795.</p> <p>B) Body support - Full body harness as specified in standard EN 361.</p> <p>C) Connecting device - Component, subsystem, connector as specified in standards EN 353-1, EN 353-2, EN 354, EN 355, EN 360, EN 362.</p>		<p>WORK POSITIONING AND RESTRAINT SYSTEMS</p> <p>Work positioning systems will hold and sustain the worker at a specific work location, limiting any free fall to 0.6m Ex. Pole work. Restraint systems prevent the worker from reaching an area where a free fall could occur Ex. Flat roof work. This system should not be used when there is a risk of free fall. Work positioning and restraint systems are specified in standard EN 358. This system consists of: (for more see "Guide for personal fall protection systems")</p> <p>A) Anchor point - Structure anchorage with known strength Min. 15kN. Ex. I-beam or Anchor device as specified in standard EN 795.</p> <p>B) Body support - Work positioning belt or harness with work positioning attachments, or sit harness with work positioning attachment point. Specified in standard EN 358 and EN 813.</p> <p>C) Connecting device - work position lanyard, connector as specified in standards EN 358, EN 362.</p> <p><i>Warning! Do not use for fall arrest purposes.</i></p>
	<p>RESCUE SYSTEMS</p> <p>Rescue systems are designed to raise or lower a worker to safety in an emergency without any possibility of a free fall. Rescue systems are typically used in confined space work or anywhere where a worker may fall or become unconscious. If possible use a backup fall arrest system together with the rescue system for added safety.</p> <p>This system consists of: (for more see "Guide for personal fall protection systems")</p> <p>A) Anchor point - Structure anchorage with known strength Min. 15kN. Ex. I-beam or Anchor device as specified in standard EN 795.</p> <p>B) Body support - Full body harness as specified in standard EN 361.</p> <p>C) Connecting device - Descender devices, optional backup fall arrest system, connector as specified in standards EN 341, EN 363, EN 362.</p>		<p>SUSPENSION SYSTEM</p> <p>A suspension system supports and holds the worker without any possibility of free fall while the worker is being raised or lowered. Painting work or window washing are common examples. Always use a backup fall arrest system together with the suspension system. This system consists of: (for more see "Guide for personal fall protection systems")</p> <p>A) Anchor point - Structure anchorage with known strength Min. 15kN. Ex. I-beam or Anchor device as specified in standard EN 795.</p> <p>B) Body support - Full body harness as specified in standard EN 361.</p> <p>C) Connecting device - Descender devices, backup fall arrest system, connector as specified in standard EN 341, EN 363, EN 362.</p>



PERSONAL FALL PROTECTION SYSTEMS

1,2,3 - PROGUARD ASSEMBLY GUIDE FOR PERSONAL FALL PROTECTION SYSTEMS



FALL ARREST SYSTEM



RESCUE SYSTEM SUSPENSION SYSTEM



WORK POSITIONING AND RESTRAINT SYSTEM

1 Anchor

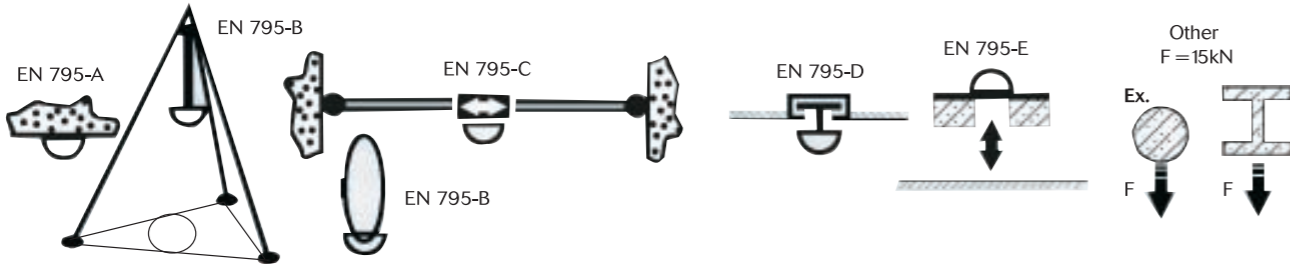

2 Connecting

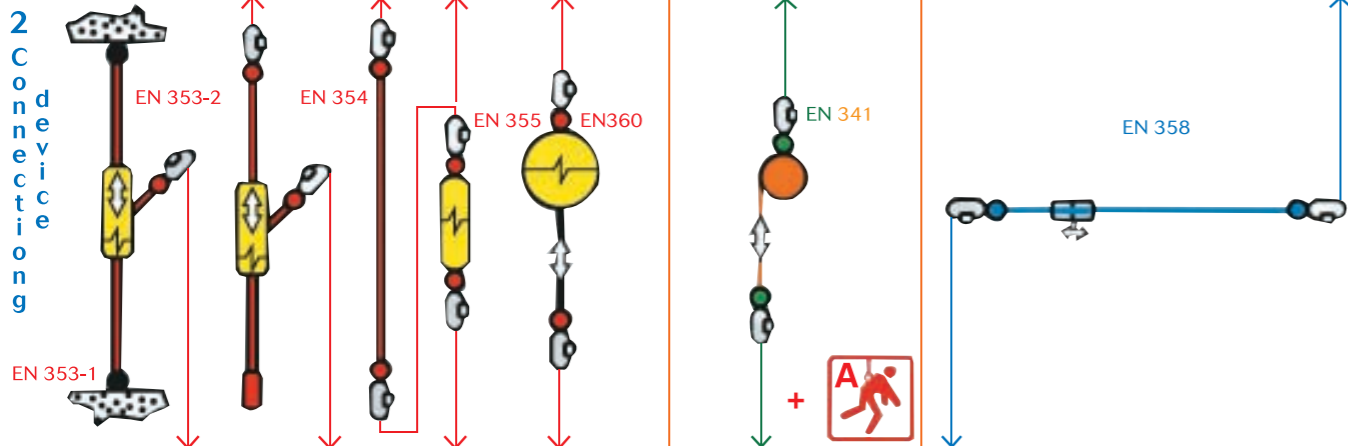

3 Body Wear

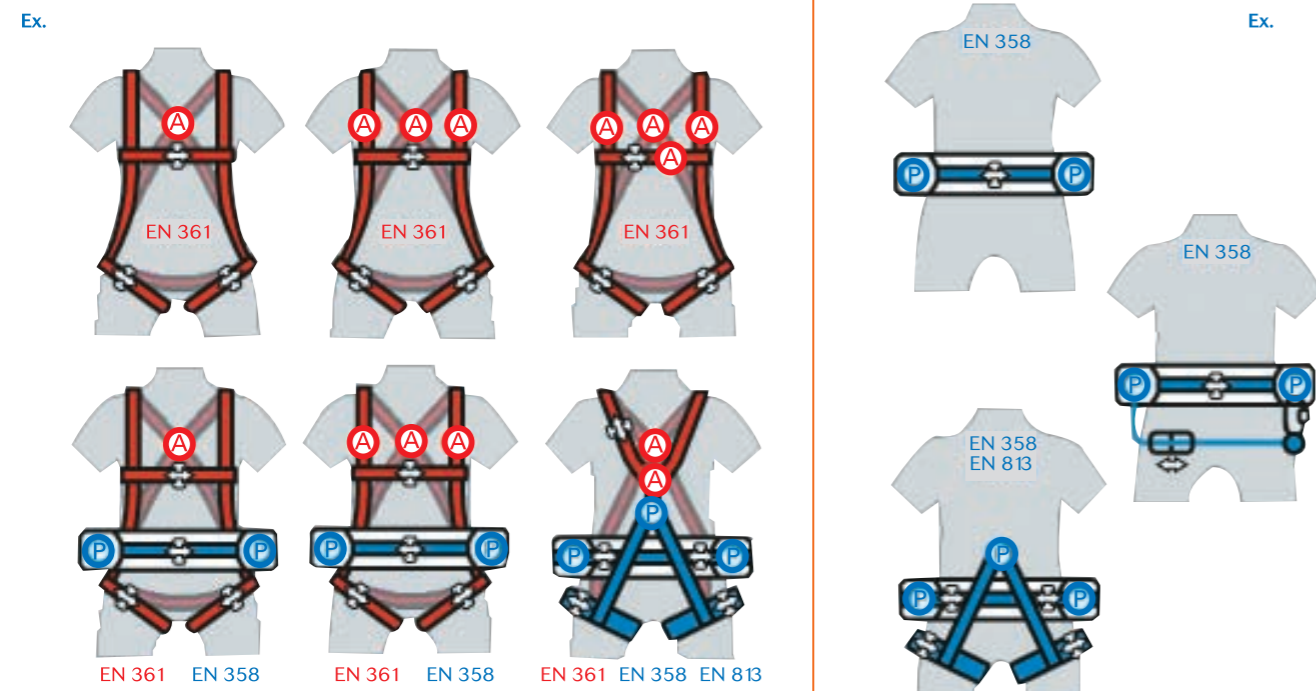

- Structure
- Anchor point
- Anchor point fixed
- Fall arrest/ rescue/ suspension point
- Work position/ restraint point
- Rescue/ suspension point
- Energy absorber Force max. 6kN
- Connector - Karabiner / Hook
- Fall arrest/rescue/ suspension point
- Work position/ restraint point
- Buckle size adjustable
- Device length adjustable



SAFETY SIGNAGES

INFORMATION ON INTERNATIONAL STANDARDS ISO 3864-2



Proguard supply a comprehensive range of safety signage for virtually any situation. All signage either complies with all current local legislation or is accepted as in common use and meets or comply with international legislation ISO3864-2 with bi-lingual of Malay & English textures.

Although a lot of signs are visually similar, it is the test of time that will tell how well they are made. Our quality safety sign work for you, year after year, conveying safety instruction and information for a safe workplace without needing replacement.

Information on International Standard ISO3864-2.

Safety colours and safety signs.

There is a need to standardize a system of giving safety information that relies as little as possible on the use of words to achieve understanding. Continued growth in international trade, travel and, more recently in the extensive mobility of labour requires a common communications method for safety information.

This International Standard prescribes the use of specific colours, geometric shapes and graphical symbols for the design of safety signs to be used as an integral part of any accident prevention, emergency provisions and risk reduction programme.

Health and Safety Regulation on Safety Signs and Signals.

Permanent signboards must be used for signs relating to prohibitions, warnings and mandatory requirements and the location and identification of emergency escape routes and first aid facilities.

Signboards and/ or a safety colour must be used to mark permanently the location and identification of fire-fighting equipment.

Signboards, including fire safety signs, are designed as follows:-



Safety Colour: RED
Meaning or Purpose: Prohibition/ Danger alarm.
Instruction & Information: Dangerous behaviour; stop; shutdown; emergency cut-out; devices; evacuate.
Intrinsic Features: Round shape; black pictogram on white background; red edging and diagonal line; red part to be at least 35% of the area of the sign.



Safety Colour: YELLOW or AMBER
Meaning or Purpose: Warning.
Instruction & Information: Be careful; take precautions; examine.
Intrinsic Features: Triangular shape; black pictogram on yellow background with black edging; yellow part to be at least 50% of the area of the sign.

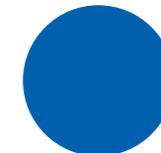

Safety Colour: BLUE
Meaning or Purpose: Mandatory.
Instruction & Information: Specific behaviour or action. e.g. wear personal protective equipment.
Intrinsic Features: Round shape; white pictogram on blue background; blue part to be at least 50% of the area of the sign.



Safety Colour: GREEN
Meaning or Purpose: Emergency escape; first aid. No danger.
Instruction & Information: Door; exits; escape routes equipment and facilities. Return to normal.
Intrinsic Features: Rectangular on square shape; white pictogram on green background; green part to be at least 50% of the area of the sign.



Safety Colour: RED
Meaning or Purpose: Fire fighting.
Instruction & Information: Identification & location.
Intrinsic Features: Rectangular or square shape; white pictogram on red background; red part to be at least 50% of the area of the sign.

Viewing Guide

To assist you in selecting the appropriate sign size.

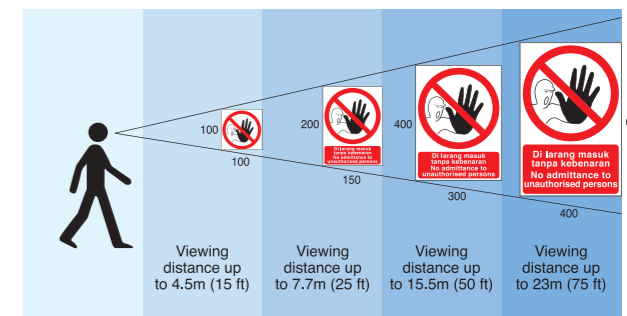

Material Specification

Self-Adhesive Label

Gloss Flexible Vinyl with permanent adhesive backing. Suitable for interior and exterior application.

Rigid Plastic Sheet

1mm semi-rigid plastic suitable for interior & exterior use especially in corrosive environments.

Photoluminescent

Used as a complement for complete evacuation route marking system. It's has a temporary visibility in the dark for the minimum period of 10 hours after exposure to light sources.

INDEX

PROGUARD SAFETY PRODUCTS CATALOGUE

3-series Safety Shoe	81-82	Concept, Safety Eyewear	23
6-series Safety Shoe	82-84	Convex Mirror, Indoor & Outdoor	76
3D Safety Sign	125	Convex Mirror, Stainless Steel	76
3M Respirators & Cartridges	39-40	Cylinder Visor	18
46-series, Safety Eyewear	27	Custom Printing Services	13
6000-series, Wellington Boots	80		
6000-series 3M Replacement Cartridge	39-40		
7000-series, Wellington Boots	81		

A

A-105 Cotton Glove	47
A2, A3 & A4 Helmet Visor Bracket	16
AHRS-1C Rope Grab	60
ABS Plastic Shower Bowl	96
ABS Plastic Eyewash Bowl	96
Absorbents, Oil	100, 103 - 105
Absorbent, Chemical	102, 103 - 105
Absorbent, Universal	101, 103 - 105
Advantage I Safety Helmet	1 - 2
Advantage II Safety Helmet	3 - 4
Advantage III Safety Helmet	5 - 6
Adhesive Floor Tape	128 - 129
Aero, Re-useable Earplugs	35
Anchor Line, Vertical	61
Anchor Connector	64
Anchor Wire	64
Anchor Webb	64
Anchor Sling	64
Anti-Slip Tape	129
Anti-Fog Goggle	28
Anti-Fog Safety Eyewear	24 & 26
Apron, Poly-Vinyl	72
Apron, Heat Resistant	71
Apron, Leather	71
Apron, LDPE	72
Argon Gloves	48
Auto Darkening Helmet	20

B

B-104 Cotton Glove	47
Badge Marking Services	76
Bag, Multi Purpose	64
Batteries, Lantern	78
Bandages, First-Aids	87
Barrier Fence	79
Barrier Tapes	128
Basic Full Body Harness	49 - 51
BC1, Bump Cap	12
Becker Earmuffs	33
Becker Economic Protective Helmets	11 - 12
BGVH, Helmet Visor Carrier	17, 29
BH7886/ BH7886-CBU Full Body Harness	51
Black Knight, Rubber Gloves	44
Blanket, Fire	107
Blanket, Welding	106
Browguard Holder, Faceshield	17
Boiler Suit	68
Boots, Wellington	80 - 81
Bump Caps,	12
Bouffant Cap	69

C

Cabinets, Safety Can Storage	98 - 99
Caps, Bump	12 - 13
Caps, Bouffant	69
Caps, Scaffold	133
Carabiner, Safety	63
Chemical Hazardous, Safety Signages	133
Chemical Sorbent	100 - 102
Chemical Dispenser Cart Spill Kit	103 - 104
Chemical Portable Spill Kit	105
Chin Strap, Helmet	13
Clear Replacement Visor	18 - 19
Classix/Classix AF Safety Goggle	28
CM-W568, Economic Welding Helmet Shield	21
Combination Shower & Eyewash	93 - 95
Conie Re-useable Earplugs	34
Cone Hazard Warning Lamp	77 - 78
Cone, Retractable	78
Cotton Gloves	45
Cotton Jacket	69
Cotton Coverall	69 - 70
Coverall, Disposable	68
Crusader, Safety Eyewear	24

D

Delineator Ropes	79
Dispenser Cart Spill Kit, Oil Only	103 - 104
Dispenser Cart Spill Kit, Chemical Only	103 - 104
Dispenser Cart Spill Kit, Universal	103 - 104
Disposal Bags, Hazardous Material	106
Disposable Coverall	68
Disposable Latex Gloves	45 - 46
Disposable Dust Mask	36
Disposable Foam Earplugs	35
Door Tags	132
Double D-ring Safety Belt	54
Dynaware, Disposable Workwear	68
Dynaware, Heat Resistant Gloves	48
Dynaware, Heat Resistant Apron	71
Dynaware, Heat Resistant Sleeves	71
Dynaware, Rainwear	66 - 67

E

EVH-1, Economic Visor Holder	17
EN471 - High Visibility Vest	73 - 75
EP-1363 & EP1368 Re-useable Earplugs	33
EV-series Polyamide Lanyards	59 - 60
Earmuffs	30 - 33
Earplugs	34 - 35
Eco, Earmuffs	30
Economic Barrier Tapes	128
Economic Foldable Earmuff	33
Economic Filter Mask	36
Economic Helmet Visor Bracket CM-HBV6	16
Economic Marine Life Jacket	65
Economic Nitrile Gloves NIT-15	43
Economic Protective Helmet, Becker	11 - 12
Economic Polyamide Lanyard	59 - 60
Economic Replacement Visor	18
Economic Visor Holder EVH-1	17
Economic Welding Head Shield	20
Economic Welding Hand Shield	20
Economic Welding Helmet Shield	21
Economic Cotton Coverall	70
Economic Safety Belt	54
Emergency Eyewash Bottle	90
Emergency Eyewash & Showers	91 - 96
Emergency Gravity-Feed Eyewash	90
Emergency Response	86 - 90
Emergency Traffic Baton	77
Embroidery Services	70
Examination Latex Gloves	45 - 46
Electrician Gloves	45
Elsec Insulation Glove	45
Energy Absorber	54
Energy Absorber, Mini	54
EPH-33R, Protective Helmet	11
Eurosafe, Emergency Traffic Baton	77
Eurosafe, Earmuffs	31 - 32
Eurosafe, Foam Earplugs	35
Eurosafe, Hazard Warning Lamp	77 - 78
Eurosafe, Particulate Respirator	37
Eurosafe, Safety Eyewear	24
Executive Uniform Shoe	85
Eye Protection	22 - 28
Eyewash, Head Assembly	96
Eyewash, Wall Mounted	91
Eyewash, Pedestal Mounted	92
Eyewear, Safety	22 - 28
Eyewash Bottle	90

F

FC48C-CE/ FC48G5-CE, Replacement	18
Cylinder Visor	
FC48C-AL, Economic Replacement Visor	18
FC48SM, Replacement Mesh Visor	19
FL-HHS24, Economic Welding Hand Shield	20
Faceshield- Browguard Holder	17
Fall Arrestor, PG 141064	62
Fall Protection Equipment	49 - 64
FFP1, FFP2 & FFP3 Respirator	37
Fire Retardant Coverall	70

Fire Signages	123 - 124
Fire Blanket	107
Fireman's Axe	107
First-Aid Kit	86 - 89
First-Aid Kit Refill	87 - 88
First-Aid Kit-OSHA	88 - 89
First-Aid Kit OSHA Refill	88 - 89
First-Aid Safety Signages	118 & 125
Filter Retainer	40
Flexibar, Traffic Control Equipment	79
FLG-35/FLR-35 Full Leather Welding Gloves	47
Floor Tapes	128 - 129
Floor Signs	130
Floor Mount Combination Shower	93 - 95
Foldable Earmuffs, Ultra	32
Foldable Earmuffs, Quaro	32
Footwear, Safety	80 - 85
Full Face Mask, IN-3000	40
Full Face Mask, INDIN-T	40
Full Face Mask, C809MG	40
Full Face Mask, SEKUR	41
Full Leather Gloves	47
Full Body Harness	49 - 51
Furniture Leather Gloves	46
Furniture Leather Apron	72

G

GeNex, Safety Eyewear	22
Glove, Argon	48
Gloves, Cotton Knitted	45
Gloves, Heat Resistant	48
Gloves, Insulation (Electrician)	45
Gloves, Full Leather	47
Gloves, Semi-Leather	46
Gloves, Nitrile	43
Gloves, Latex	45 - 46
Gloves, Neoprene	43
Gloves, Heveaprene	44
Gloves, Max Grip	44
Gloves, Rubber Black Knight	44
Gloves, PVC Coated	44
Gloves, PU Coated	45
Gloves, Polyethylene	45
Gloves, Polka-Dot	47
Gloves, Superior Rigger Chrome Leather	46
Gloves, Welding	47
Glove, Max Grip	44
Glove Holder	108
Goggle, Classix	28
Goggle, Welding	28

H

Half-mask Respirator	39
Hand Protection	43 - 48
Harness, Helmet	14 - 15
Hand Shield, Welding	20
Head Shield, Welding	20 - 21
Harness, Full Body	49 - 51
Hazard Warning Lamp	77 - 78
Hazardous Material Disposal Bag	106
Head Protection	1 - 21
Hearing Protection	30 - 35
Heat Resistant Gloves	48
Heat Resistant Apron	71
Heat Resistant Sleeve	71
Heavy Duty Raincoat & Rainsuit	66 - 67
Heavy Duty Boiler Suit	68
Helmet Mounted Faceshield Bracket	16 - 17
Helmet Slotted Earmuff	29
Helmet, Replacement Accessories	13 - 15
Helmet, Safety	1 - 13
Helmet Shade Brims	13
Helmet Visor Bracket A2, A3 & A4	16
Helmet Visor Carrier BGVH	17
Helmet, Auto Darkening	20
Heveaprene Glove	44
Hi-visibility Emergency Traffic Baton	77
Hi-visibility Safety Vest	73 - 75
Holder, Utility	108
Holder, Glove	108
Horizontal Anchorage Lifelines	61

I

Identification Tags	132 - 133
IMO, Safety Signage	121 - 123
INAIR, Replacement Filter	41 - 42
INAIR, Full Face Mask	40
Infinity, Earmuff	31
Information Signages	131
Insulation Glove (Electrician Glove)	45
Impact Resistant Replacement Welding Clear Lens	21
IRIS, Safety Eyewear	23

J

Jacket, Cotton	69
Jacket, Welding	72

K

Kleenguard Disposable Coverall	68
--------------------------------	----

L

Lanyard, Webbing	55 - 57
Lanyard, Polyamide	57 - 60
Large Opening Hook	63
Latex, Disposable Gloves	45 - 46
Lantern Battery	78
LDPE Apron	71
Leather Gloves	47
Leather Apron, Synthetic	72
Leather Apron, Furniture	72
Leather Protective Apron	71
Leather Protective Sleeve	71
Leather Jacket, Welding	72
Leather Trousers, Welding	72
Leather Foot Guard	72
Life Jacket, Marine	65
Life Lines	61
Lifting Support Belt	90
Lockout Tags	127

M

Mandatory, Safety Signages	109 - 112
Mask, Respirator	37 - 42
Mask, Full Face	40 - 41
Maintenance Tags	127
Marine Life Jackets	65
Max Grip Gloves	44
Medallas Safety Eyewear	24
Megatron 5, Safety Helmet	11
Mesh Replacement Visor	19
Millennium Earmuff	31
Mini Block	62
Mini Energy Absorber	54
Multi-Message, Safety Signages	117

N

Neoprene Gloves	43
Nitrile Gloves	43
Non-Printed, Barrier Tape	128

O

Oil Only Sorbent	100
Oil Only, Dispenser Cart Spill Kit	103 - 104
Oil Only, Portable Spill Kit	105
Optimus Safety Helmet	7 - 10
Oversleeve, PVC	71
Outdoor Convex Mirror	76
OSHA, First-Aid Kit/ First Aid Refill	88 - 89

P

Packaging Signages	131
Particulate Respirators	37 - 38
Pedestal Mounted Eyewash	92
Personal Blinker	77
Pear Quick Link	63
PG-series Argon Glove	48
PG-series, Full Body Harness	49 - 51
PG-series Safety Belts	54
PG-series Work Positioning Belt	52 - 53
Fall Arrestor	62
PG-series Polyamide Lanyards	55 - 58

Phantom, Earmuff	31
Photoluminescent, Safety Signages	120 - 124
Photoluminescent Tapes	131
Plastic Harness, Helmet	14 - 15
Tapes, Barrier	47
Polyamide Lanyards	57 - 60
Polyamide Rope PR12/PR14/PR16	62
Polyethylene Disposable Apron	71
Polyethylene Disposable Gloves	45
Poly-Vinyl Apron	72
Portable Spill Kit	105
Press Snap Hook	63
Printing Service, Helmet	13
Prohibition, Safety Signages	115 - 116
Prolgnite, Safety Eyewear	22
Promesh Respirator P2	38
Protective Helmet	11 - 12
Protective Clothing	68
PU Coated Gloves	45
PVC Coated Gloves	44
PVC Oversleeve	71

Q

Quantum Earmuff	32
Quick Link, Triangle Shape	63
Quick Link, Pear Shape	63

R

Rainwear Protection	66 - 67
Reflective Delineator Rope	79
Respirator Protection	36 - 42
Responder, Safety Eyewear	24
Replacement Chin Strap	13
Replacement Dust Cartridge	39
Replacement Chemical Cartridge	39
Replacement Filters, INAIR	41 - 42
Replacement Filters, SEKUR	41
Replacement Helmet Harness	14 - 15
Replacement Respirator Cartridge	39 - 42
Replacement Scaffold Tags	133
Replacement Sweatband	13
Replacement Wind Sock	107
Replacement Visor	18 - 19
Retractable Safety Cones	78
Re-useable Earplugs	33 - 34
Rigger Leather Gloves	46
Rigger Safety Shoe	82 & 84
Road Barrier	79
Rope Grab	60

S

Safe Procedure, Safety Signages	118
Safety Belts	54
Safety Block	62
Safety Cans	97
Safety Cabinets	98-99
Safety Eyewear	22 - 28
Safety Faceshield	16 - 19
Safety Footwear	80 - 85
Safety Floor Sign	130
Safety Goggle	28
Safety Harness, Fall Protection	49 - 51
Safety Helmets	1 - 13
Safety Helmet Printing Services	13
Safety Signages	109 - 133
Safety Vest, Hi-visibility	73 - 75
Safety Work Positioning Belt	52 - 53
Scaffold Tag System	132 - 133
Scaffold Caps	133
Seat Harness, Fall Protection	53
Sector 5, Safety Eyewear	25
Self Contained Breathing Apparatus (SCBA)	41
SEKUR, Full Face Mask & Replacement Filters	41
Semi Leather Gloves	46
Shoe Cover	69
Spectacles Cord	28
Spectacles Pouch	28
Spill Control	100 - 105
Spring Lanyard	55 - 56
Stainless Steel Convex Mirror	76
Starlite Safety Eyewear	25
Stretcher, Single & Double Fold	90
Surgical Face Mask, 3-ply	36
Super Nitrile Gloves	43
Sweatband, Helmet	13
Synthetic Leather Apron	72

T

Tapes, Anti-Slip	129
Tapes, Barrier	128